



staffe e collari per fissare tubi
clamps for all clamping applications

eosi[®]
clamps



indice

<i>Introduction</i>	4	Introduzione
<i>Mounting suggestions</i>	12	Suggerimenti per il montaggio
<i>Production program</i>	14	Programma di produzione
<i>Complete clamps standard series with upper plate</i>	17	Collari serie standard in polipropilene, con piastra superiore
<i>Complete clamps standard series</i>	19	Collari completi serie standard
<i>Complete stacking clamps standard series</i>	21	Collari completi raggruppati serie standard con piastra superiore raggruppato
<i>Special plates for standard series</i>	28	Piastre speciali per serie standard
<i>Complete clamps for twin tubes</i>	29	Collari completi standard per tubi gemellati
<i>Complete clamps double series</i>	31	Collari completi serie doppia
<i>Complete stacking clamps double series</i>	32	Collari completi serie doppi raggruppati
<i>Clamps for hoses, pipes, tubes and cables</i>	39	Elementi di fissaggio per tubi rigidi, flessibili e cavi elettrici
<i>Complete clamps heavy duty series</i>	41	Collari completi serie pesante
<i>Complete stacking clamps heavy duty series</i>	42	Collari completi raggruppati serie pesante
<i>Double plates for heavy duty series</i>	50	Piastre doppie per serie pesante
<i>Pipe clamps for cylinder</i>	51	Supporto tra tubo e cilindro
<i>Materials properties</i>	50	Caratteristiche materiali
<i>General sales conditions</i>	53	Condizioni generali di vendita

AEGI clamps inizia la sua attività nella produzione di collari ferma tubo e di sistemi per il fissaggio di tubi nel 1990. Oggi l'azienda si colloca tra i maggiori produttori mondiali di questi prodotti. Il grande patrimonio di esperienza e di capacità innovativa uniti all'alto livello tecnologico raggiunto, i rigidi e sistematici controlli di qualità, l'estrema flessibilità nel soddisfare le esigenze dei clienti (produzioni particolari o su disegno, tempi di consegna celeri...) le hanno permesso di raggiungere all'interno del mercato mondiale una posizione di assoluto rilievo. Inoltre dal 2003 Aegi Clamps è certificata ISO 9001 con l'ente certificatore TÜV NORD.

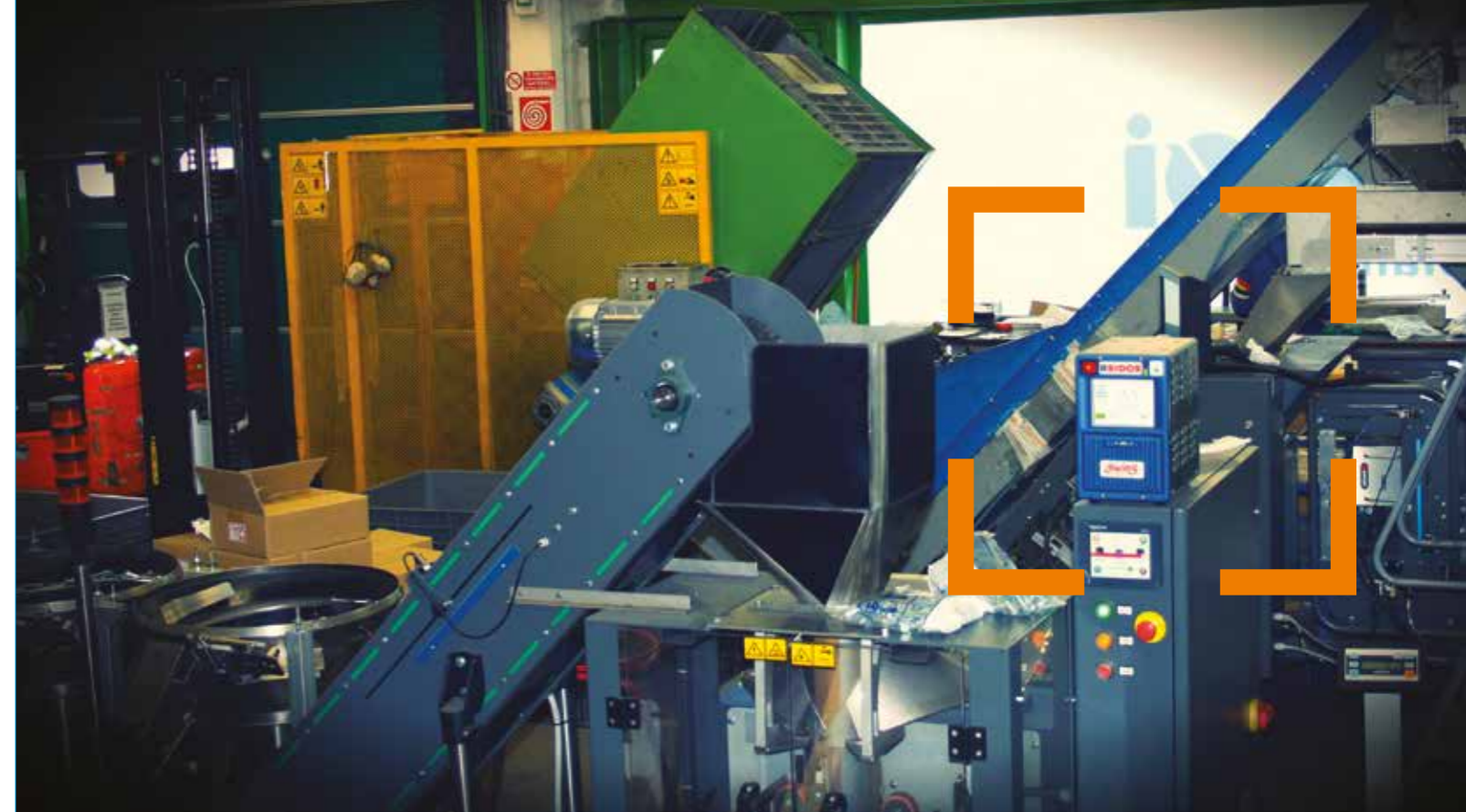

AEGI
clamps

***AEGI clamps**, born in 1990, thanks to its experience, main and innovative capacity, it has attained a worldwide leading position as clamps producer. The company is universally recognized for its high engineering standards, strict devotion to quality and trustworthy delivery service. Since 2003 Aegi Clamps is certified ISO 9001 with TÜV NORD.*





staffe e collari



Le staffe ed i collari AEGI rappresentano il sistema più semplice, veloce e razionale per fissare tubi, sia rigidi che flessibili, in qualsiasi campo industriale, navale, elettrico.

Clamps of AEGI are a sensible and easy way for securing piping and hoses in all type of industries and on all types of terrestrial and marine installations.

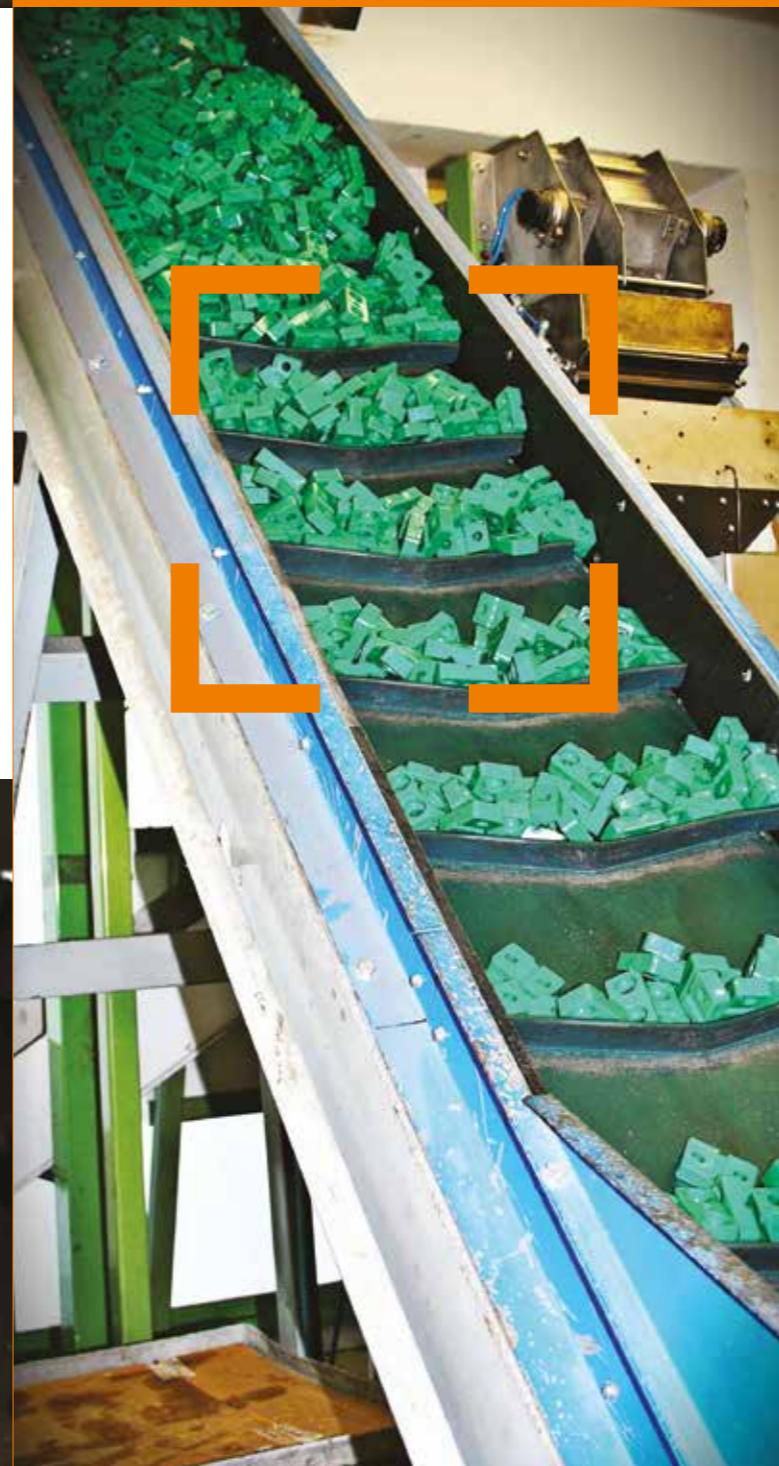

Le staffe e i collari AEGI sono di facile impiego e permettono di fissare tubi, cavi elettrici, guaine, canaline, ecc., in modo sicuro, rapido ed economico.

Esteticamente e tecnicamente valide, possono venir agganciate con la massima facilità su qualsiasi tipo di struttura fissa per mezzo di guide saldabili.

- Tutti i particolari sono costruiti con riferimento alle norme DIN 3015.

Clamps of AEGI are fast to mount, easy and economic:

- *manufactured with reference to DIN 3015*
- *pleasant, practical and economical design*
- *using welding plates or rails, it's easy to fix the clamps to machines and plans*



I collari delle staffe AEGI vengono prodotti nei seguenti materiali:

- Polipropilene copolimero - di colore verde e nero - per la serie standard, pesante e doppia
- Poliammide - di colore nero - (Nylon 6-6 caricato al 20% con fibra di vetro, autoestinguento VO), per la serie standard, pesante e doppia
- Alluminio, per la serie leggera e pesante
- Gomma - di colore nero - per serie standard doppia e pesante.

AEGI pipe clamps are manufactured in:

- *Polypropylene - green or black colour - for standard, heavy duty and double series*
- *Polyamide - black colour - (Nylon 6-6 loaded with 20% of fiberglass self-extinguishing VO) for standard, heavy duty and double series*
- *Aluminium for standard and heavy duty series*
- *Rubber - black colour - for standard double and heavy duty series*



piastre
e binari

Gli altri componenti delle staffe vengono prodotti, di serie, con i seguenti materiali:

- Piastra inf. e sup.: acciaio FE 36 e acciaio inox 316L
- Viti e rondelle: acciaio 8.8 e acciaio inox 304
- Binari: acciaio FE 36 e acciaio inox 304

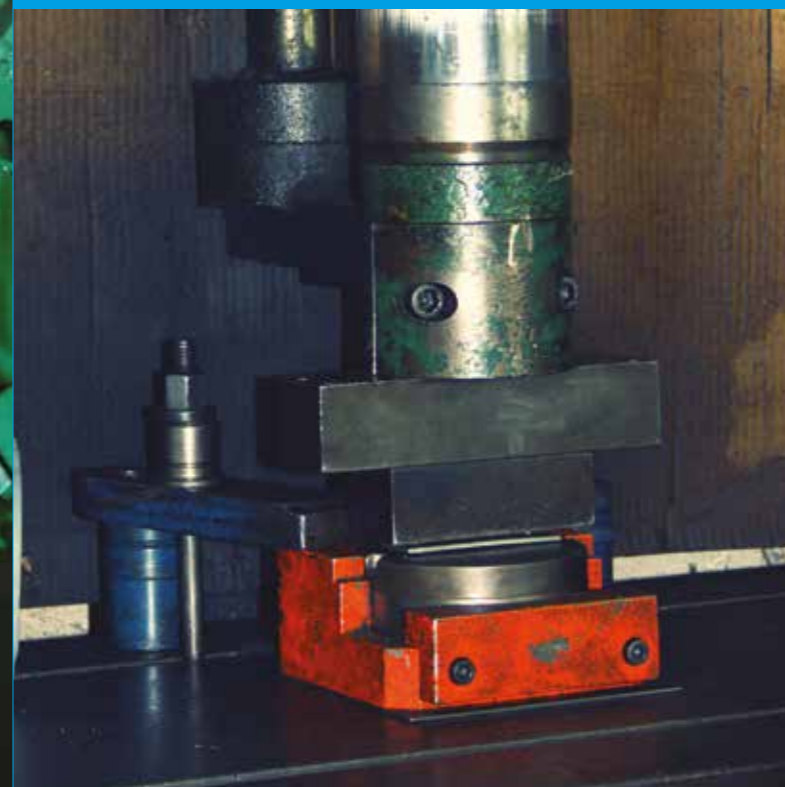

polipropilene
poliammide
alluminio
gomma

The other metallic components of the clamps are manufactured in:

- *Lower and upper plate: Steel FE 36 and stainless steel 316L*
- *Screw and washer: Steel 8.8 and stainless steel 304*
- *Rail: Steel FE 36 and stainless steel 304*



Suggerimenti per il montaggio

Montaggio con piastra a saldare

Posizionare la piastra inferiore nella posizione prescelta e bloccarla con un magnete o con un'appropriata attrezzatura. Saldare quindi la piastra. Inserire il semiguscio inferiore della staffa, posizionare il tubo, mettere il secondo semiguscio e serrare le viti. Non saldare la piastra inferiore con la staffa di plastica montata. Le piastre inferiori allungate possono essere avvitate direttamente sul telaio della macchina. Attenzione agli interassi dei tubi (si sconsiglia il contatto fra due semigusci).

Montaggio con binario

I binari sono forniti con lunghezza di 2 metri. Saldare o avvitare il binario sul telaio della macchina, inserire il dado scorrevole nel binario e girarlo leggermente in modo che non possa ruotare, inserire la parte inferiore della staffa, posizionare il tubo, mettere il secondo semiguscio e serrare le viti. Attenzione agli interassi dei tubi (si sconsiglia il contatto fra due semigusci).

Montaggio raggruppato

Consiste nel montare due staffe una sopra l'altra usando due viti speciali. Con questo montaggio si possono raggruppare due o più staffe bloccando le viti speciali con un'appropriata piastrina di sicurezza.

Mounting details

Weld plate mounting

Weld lower plate in position. Press on lower clamp half, lay tube, put on top clamp half, insert screws and tighten. Don't weld with plastic clamps on them. Prolonged lower plate can be screwed directly to the surface. Ensure the clamp halves are not in contact with each other.

Rails mounting

Mounting rails are supplied in 2m lengths. Weld or screw mounting rail in position. Insert nut into rail and turn to fix at correct spacing. Press on lower clamp half, lay tube, put on top clamp half, insert screw and tighten. Ensure the clamp halves are not in contact with each other.

Stacking

Consists of 2 clamp halves, stacking bolt(s) and a bolt locking plate. To construct a stack, fasten a weld plate or rail nut and locate 2 clamp halves and tube, securing with stacking bolt(s). Once tight, these bolts must be held with a locking plate. The next clamp can then be assembled and so on, until the stack is complete, the last clamp being secured with conventional bolt(s) and top plate.

Ø est. tubo Ø tube	Distanza fra le staffe in m Distances of clamps in meters
a 6 bis 12,7	0,9
a 15 bis 22	1,2
a 23 bis 28	1,5
a 30 bis 38,1	2
a 40 bis 48,3	2,5
a 50 bis 57	3
a 60 bis 70	3,4
a 76,1 bis 88,9	3,7
a 101,6 bis 108	4
a 114,3 bis 133	4,3
a 139,7 bis 165,1	5
a 168,3 bis 324	5,5

Distanza suggerita tra una staffa e l'altra dello stesso gruppo. Posizionare le staffe prima e dopo una curva a 90° (a gomito).

Recommend distance for installation of clamps of same group code. When an elbow or bend be supported the clamps, should be positioned as close as possible on each side of the bend.



Serie - Series		Nm/Material			
		Polypropylen	Polyamide	Aluminium	
Standard	M 6	8	10	12	
Doppia Twin	Gr. 1	M 6	5	6	-
	Gr. 2 ÷ 4	M 8	12	12	-
	Gr. 5		8	8	-
Pesante Heavy	Gr. 1	M 10	12	20	30
	Gr. 2		12	20	30
	Gr. 3		15	25	35
	Gr. 4	M 12	30	40	55
	Gr. 5	M 16	45	55	120
	Gr. 6	M 20	80	150	220
	Gr. 7	M 24	110	200	250
	Gr. 8	M 30	180	350	500
	Gr. 9	M 30	200	370	500

Max. momento torcente per il fissaggio delle viti. Staffe con piastra superiore.

Max. bolt tightening Torque in Nm, for clamps with upper plate.



Programma di produzione

Production program

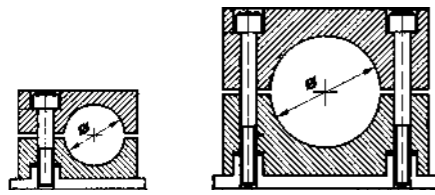

collari serie standard
standard clamps

DIN gruppo group	diametro tubo pipe diameter		
	Ø mm	foro nominale nominal bore	Ø pollici inch. O.D.
0	6		
	8		5/16"
	10	G 1/8"	
	12		
1	6,4		1/4"
	8		5/16"
	9,5		3/8"
	10	G 1/8"	
	12,7		1/2"
2	13,5	G 1/4"	
	14		
	15		
	16		5/8"
	17,2	G 3/8"	
	18		
	19		3/4"
3	19		3/4"
	20		3/4"
	21,3	G 1/2"	
	22		7/8"
	23		
	25		
4	25,4		1"
	26,9	G 3/4"	
	28		
	30		
	32		1 1/4"
	32		1 1/4"
	33,7	G 1"	
5	35		
	38		1 1/2"
	40		
	42	G 1 1/4"	
	45		
6	44,5		1 3/4"
	48,3	G 1 1/2"	
	50,8		2"

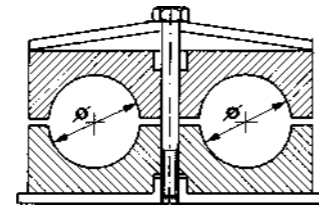

collari serie doppia
double series clamps

DIN gruppo group	diametro tubo pipe diameter		
	Ø mm	foro nominale nominal bore	Ø pollici inch. O.D.
0	6		
	6,4		1/4"
	8		5/16"
	9,5		3/8"
	10	G 1/8"	
1	12		
	12,7		1/2"
	13,5	G 1/4"	
	14		
	15		
	16		5/8"
2	17,2	G 3/8"	
	18		
	19		3/4"
	20		
	21,3	G 1/2"	
	22		7/8"
	25		
3	25,4		1"
	26,9	G 3/4"	
	28		
	30		
	32		1 1/4"
4	32		1 1/4"
	33,7	G 1"	
	35		
	38		1 1/2"
	40		
42	G 1 1/4"		

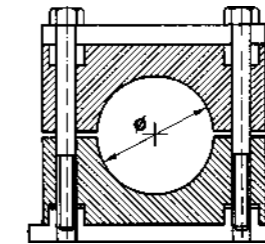

collari serie pesante
heavy duty clamps

DIN gruppo group	diametro tubo pipe diameter		
	Ø mm	foro nominale nominal bore	Ø pollici inch. O.D.
0	6		
	6,4		1/4"
	8		5/16"
	9,5		3/8"
	10	G 1/8"	
1	12		
	12,7		1/2"
	13,5	G 1/4"	
	14		
	15		
	16		5/8"
2	17,2	G 3/8"	
	18		
	19		3/4"
	20		
	21,3	G 1/2"	
	22		7/8"
	25		
3	25,4		1"
	26,9	G 3/4"	
	28		
	30		
	30		
	32		1 1/4"
	33,7	G 1"	
	35		
4	38		1 1/2"
	40		
	42	G 1 1/4"	
	38		1 1/2"
	42	G 1 1/4"	
	42	G 1 1/4"	
	44,5		1 3/4"
	48,3	G 1 1/2"	
	50		
50,8		2"	
5	55		
	57		2 1/4"
	60,3	G 2"	
	63,5		2 1/2"
	65		
	70		2 3/4"

DIN gruppo group	diametro tubo pipe diameter		
	Ø mm	foro nominale nominal bore	Ø pollici inch. O.D.
0	65		
	70		2 3/4"
	73		
	75		
	76,1	G 2 1/2"	
1	80		
	82,5		3 1/4"
	88,9	G 3"	3 1/2"
	88,9	G 3"	3 1/2"
	100		
	101,6	G 3 1/2"	4"
2	108		4 1/4"
	114,3	G 4"	4 1/2"
	127	G 4 1/2"	5"
	133		5 1/2"
	133		5 1/4"
	139,7	G 5"	5 1/2"
	152,4	G 5 1/2"	6"
3	165		6 1/2"
	168,3	G 6"	
	168,3	G 6"	
	177,8		7"
	193,7		7 5/8"
	216		8 1/2"
	219,1	G 8"	

Collari completi serie standard
con piastra superiore
*Complete clamps standard series
with upper plate*

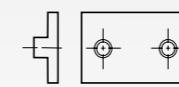

APIN
1

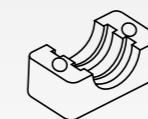

A.....S
2x

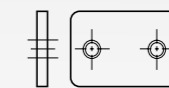

APS
1



AVTE
2x

A = polipropilene
polypropylene
MA = polyamide
self-extinguishing

RA = gomma
rubber
LA = alluminio
aluminium

Collari serie standard con piastra superiore in polipropilene, poliammide autoestinguente, gomma o alluminio

Standard clamps with upper plate in polypropylene, self-extinguishing polyamide, rubber or aluminium

Collari completi serie standard
Complete clamps standard series

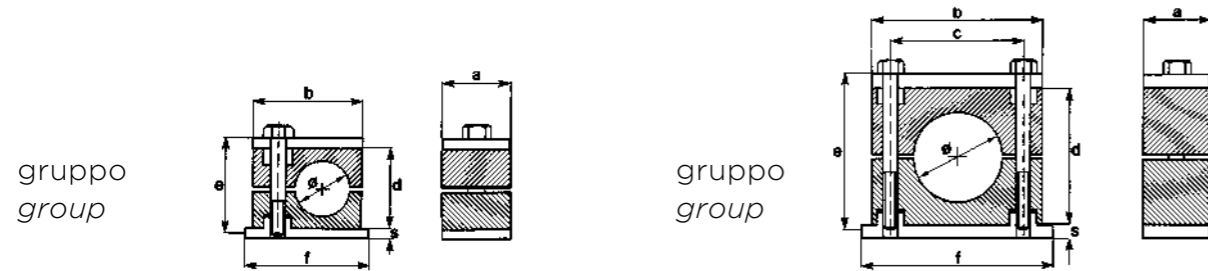

DIN gruppo group	diametro tubo pipe diameter			tipo di collare clamp type				dimensioni in mm dimension in mm							pezzi per confezione box quantity
	Ø mm	pollici / inches G	Ø O.D.	A polipropilene polypropylene	MA poliammide self-extinguishing	RA gomma rubber	LA alluminio aluminium	a	b	c	d	f	s	e	
0	6			A0 06+APS	MA 0 06+APS	-	-	30	28	-	27	32	3	M6x30	50
	8		5/16"	A0 08+APS	MA0 08+APS	-	-								
	10		1/8"	A0 10+APS	MA0 10+APS	-	-								
	12			A0 12+APS	MA0 12+APS	-	-								
1	6			A1 06+APS	MA1 06+APS	RA1 06+APS	LA1 06+APS	30	35	20	27	42	3	M6x30	50
	6,4		1/4"	A1 6,4+APS	MA1 6,4+APS	RA1 6,4+APS	-								
	8		5/16"	A1 08+APS	MA1 08+APS	RA1 08+APS	LA1 08+APS								
	9,5		3/8"	A1 9,5+APS	MA1 9,5+APS	RA1 9,5+APS	-								
	10		1/8"	A1 10+APS	MA1 10+APS	RA1 10+APS	LA1 10+APS								
	12			A1 12+APS	MA1 12+APS	RA1 12+APS	LA1 12+APS								
2	12,7		1/2"	A2 12,7+APS	MA2 12,7+APS	RA2 12,7+APS	-	30	41	26	33	48	3	M6x35	50
	13,5		1/4"	A2 1/4"+APS	MA2 1/4"+APS	RA2 1/4"+APS	LA2 1/4"+APS								
	14			A2 14+APS	MA2 14+APS	RA2 14+APS	LA2 14+APS								
	15			A2 15+APS	MA2 15+APS	RA2 15+APS	LA2 15+APS								
	16		5/8"	A2 16+APS	MA2 16+APS	RA2 16+APS	LA2 16+APS								
	17,2		3/8"	A2 3/8"+APS	MA2 3/8"+APS	RA2 3/8"+APS	LA2 3/8"+APS								
	18			A2 18+APS	MA2 18+APS	RA2 18+APS	LA2 18+APS								
	19		3/4"	A2 19+APS	MA2 19+APS	RA2 19+APS	-								
3	19		3/4"	A3 19+APS	MA3 19+APS	RA3 19+APS	LA3 19+APS	30	48	33	35	55	3	M6x40	50
	20			A3 20+APS	MA3 20+APS	RA3 20+APS	LA3 20+APS								
	21,3		1/2"	A3 1/2"+APS	MA3 1/2"+APS	RA3 1/2"+APS	LA3 1/2"+APS								
	22		7/8"	A3 22+APS	MA3 22+APS	RA3 22+APS	LA3 22+APS								
	23			A3 23+APS	MA3 23+APS*	RA3 23+APS*	-								
	25			A3 25+APS	MA3 25+APS	RA3 25+APS	LA3 25+APS								
4	25,4		1"	A3 25,4+APS	MA3 25,4+APS	RA3 25,4+APS	-	30	57	40	42	62	3	M6x45	25
	26,9		3/4"	A4 3/4"+APS	MA4 3/4"+APS	RA4 3/4"+APS	LA4 3/4"+APS								
	28			A4 28+APS	MA4 28+APS	RA4 28+APS	LA4 28+APS								
	30			A4 30+APS	MA4 30+APS	RA4 30+APS	LA4 30+APS								
	32		1 1/4"	A4 32+APS	MA4 32+APS	RA4 32+APS	LA4 32+APS								
5	32		1"	A5 32+APS	MA5 32+APS	RA5 32+APS	LA5 32+APS	30	69	52	58	74	3	M6x60	25
	33,7			A5 1"+APS	MA5 1"+APS	RA5 1"+APS	LA5 1"+APS								
	35			A5 35+APS	MA5 35+APS	RA5 35+APS	LA5 35+APS								
	38		1 1/2"	A5 38+APS	MA5 38+APS	RA5 38+APS	LA5 38+APS								
	40			A5 40+APS	MA5 40+APS	RA5 40+APS	LA5 40+APS								
	42		1 1/4"	A5 1 1/4"+APS	MA5 1 1/4"+APS	RA5 1 1/4"+APS	LA5 1 1/4"+APS								
6	45			A5 45+APS	MA5 45+APS	RA5 45+APS	LA5 45+APS	30	86	66	66	88	3	M6x70	25
	44,5		1 3/4"	A6 44,5+APS	MA6 44,5+APS	RA6 44,5+APS	LA6 44,5+APS								
	48,3		1 1/2"	A6 1 1/2"+APS	MA6 1 1/2"+APS	RA6 1 1/2"+APS	LA6 1 1/2"+APS								
	50,8		2"	A6 50,8+APS	MA6 50,8+APS	RA6 50,8+APS	LA6 50,8+APS								

* on request with minimum quantity - articolo a richiesta con quantitativo minimo

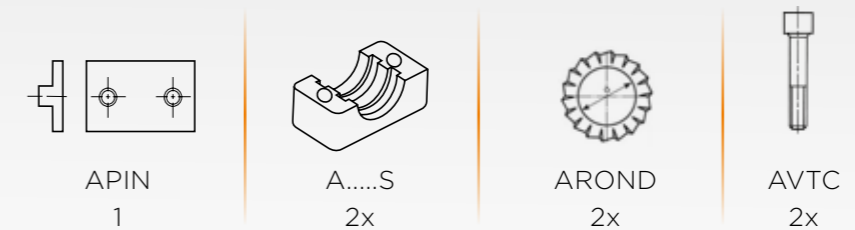

A = polipropilene
polypropylene

MA = polyamide
self-extinguishing

RA = gomma
rubber

LA = alluminio
aluminium

Collari serie standard in polipropilene,
poliammide autoestinguente, gomma o alluminio

Standard clamps in polypropylene,
self-extinguishing polyamide, rubber or aluminium

Collari completi serie standard
con piastra superiore raggruppato

Complete stacking clamps standard series

gruppo
group

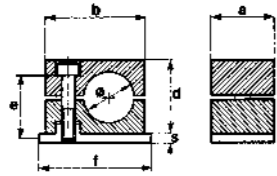

gruppo
group

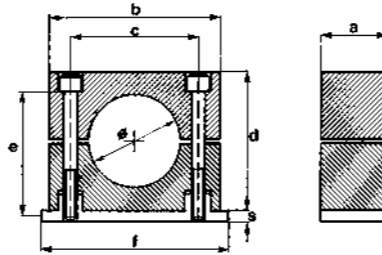

DIN gruppo group	diametro tubo pipe diameter			tipo di collare clamp type				dimensioni in mm dimension in mm							pezzi per confezione box quantity		
	Ø mm	pollici / inches G	Ø O.D.	A polipropilene polypropylene	MA polyamide self-extinguishing	RA gomma rubber	LA alluminio aluminium	a	b	c	d	f	s	e			
0	6			A0 06	MA 0 06	-	-									M6x20	50
	8		5/16"	A0 08	MA0 08	-	-										
	10		1/8"	A0 10	MA0 10	-	-	30	28	-	27	31,5	3				
	12			A0 12	MA0 12	-	-										
1	6			A1 06	MA1 06	RA1 06	LA1 06								M6x20	50	
	6,4		1/4"	A1 6,4	MA1 6,4	RA1 6,4	-										
	8		5/16"	A1 08	MA1 08	RA1 08	LA1 08										
	9,5		3/8"	A1 9,5	MA1 9,5	RA1 9,5	-										
	10		1/8"	A1 10	MA1 10	RA1 10	LA1 10										
	12			A1 12	MA1 12	RA1 12	LA1 12										
2	12,7		1/2"	A2 12,7	MA2 12,7	RA2 12,7	-								M6x25	50	
	13,5		1/4"	A2 1/4"	MA2 1/4"	RA2 1/4"	LA2 1/4"										
	14			A2 14	MA2 14	RA2 14	LA2 14										
	15			A2 15	MA2 15	RA2 15	LA2 15										
	16		5/8"	A2 16	MA2 16	RA2 16	LA2 16										
	17,2		3/8"	A2 3/8"	MA2 3/8"	RA2 3/8"	LA2 3/8"										
	18			A2 18	MA2 18	RA2 18	LA2 18										
	19		3/4"	A2 19	MA2 19	RA2 19	-										
3	19		3/4"	A3 19	MA3 19	RA3 19	LA3 19								M6x30	50	
	20			A3 20	MA3 20	RA3 20	LA3 20										
	21,3		1/2"	A3 1/2"	MA3 1/2"	RA3 1/2"	LA3 1/2"										
	22		7/8"	A3 22	MA3 22	RA3 22	LA3 22										
	23			A3 23	MA3 23*	RA3 23*	-										
	25			A3 25	MA3 25	RA3 25	LA3 25										
	25,4			A3 25,4	MA3 25,4	RA3 25,4	-										
	26,9		3/4"	A4 3/4"	MA4 3/4"	RA4 3/4"	LA4 3/4"										
4	28			A4 28	MA4 28	RA4 28	LA4 28								M6x35	25	
	30			A4 30	MA4 30	RA4 30	LA4 30										
	32		1 1/4"	A4 32	MA4 32	RA4 32	LA4 32										
	32		1 1/4"	A5 32	MA5 32	RA5 32	LA5 32										
	33,7		1"	A5 1"	MA5 1"	RA5 1"	LA5 1"										
5	35			A5 35	MA5 35	RA5 35	LA5 35								M6x50	25	
	38		1 1/2"	A5 38	MA5 38	RA5 38	LA5 38										
	40			A5 40	MA5 40	RA5 40	LA5 40										
	42		1 1/4"	A5 1 1/4"	MA5 1 1/4"	RA5 1 1/4"	LA5 1 1/4"										
	45			A5 45	MA5 45	RA5 45	LA5 45										
6	44,5		1 3/4"	A6 44,5	MA6 44,5	RA6 44,5	LA6 44,5								M6x60	25	
	48,3		1 1/2"	A6 1 1/2"	MA6 1 1/2"	RA6 1 1/2"	LA6 1 1/2"										
	50,8		2"	A6 50,8	MA6 50,8	RA6 50,8	LA6 50,8										

* on request with minimum quantity - articolo a richiesta con quantitativo minimo

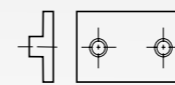

APIN
1



A....S
4x



APMRS
1x

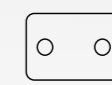

APS
1x



AVTE
2x



AVTEA
2x

A = polipropilene
polypropylene

RA = gomma
rubber

MA = polyamide
self-extinguishing

LA = alluminio
aluminium

A.....S



tipo H interno liscio
H model smooth inside



tipo normale interno sagomato
normal model profiled inside

DIN gruppo	semi-collare clamp-half	DIN gruppo	semi-collare clamp-half	
0	A0 06 S	3	A3 19 S	
	A0 08 S		A3 20 S	
	A0 10 S		A3 1/2" S	
	A0 12 S		A3 22 S	
1	A1 06 S	4	A3 23 S	
	A1 6,4 S		A3 25 S	
	A1 08 S		A3 25,4 S	
	A1 9,5 S		A4 3/4" S	
	A1 10 S		A4 28 S	
	A1 12 S		A4 30 S	
2	A2 12,7 S	5	A4 32 S	
	A2 1/4" S		A5 32 S	
	A2 14 S		A5 1" S	
	A2 15 S		A5 35 S	
	A2 16 S		A5 38 S	
	A2 3/8" S		A5 40 S	
	A2 18 S		A5 11/4" S	
	A2 19 S		A5 45 S	
	6			A6 44,5 S
				A6 11/2" S
		A6 50,8 S		

APIN

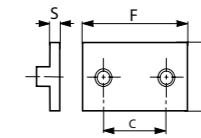
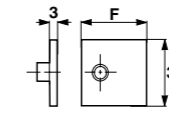

DIN gruppo	APIN	F mm	c mm
0	APIN0	32	-
1	APIN1	41	20
2	APIN2	46	26
3	APIN3	54	33
4	APIN4	61	40
5	APIN5	73	52
6	APIN6	89	66

A.....C



tipo H interno liscio
H model smooth inside



tipo normale interno sagomato
normal model profiled inside

DIN gruppo	coppia collari clamp body (2 halves)	DIN gruppo	coppia collari clamp body (2 halves)	
0	A0 06 C	3	A3 19 C	
	A0 08 C		A3 20 C	
	A0 10 C		A3 1/2" C	
	A0 12 C		A3 22 C	
1	A1 06 C	4	A3 23 C	
	A1 6,4 C		A3 25 C	
	A1 08 C		A3 25,4 C	
	A1 9,5 C		A4 3/4" C	
	A1 10 C		A4 28 C	
	A1 12 C		A4 30 C	
2	A2 12,7 C	5	A4 32 C	
	A2 1/4" C		A5 32 C	
	A2 14 C		A5 1" C	
	A2 15 C		A5 35 C	
	A2 16 C		A5 38 C	
	A2 3/8" C		A5 40 C	
	A2 18 C		A5 11/4" C	
	A2 19 C		A5 45 C	
	6			A6 44,5 C
				A6 11/2" C
		A6 50,8 C		

APIA

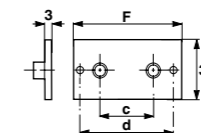
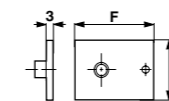

DIN gruppo	APIA	F mm	c mm	d mm
0	APIA0	46	-	-
1	APIA1	64	20	51
2	APIA2	70	26	56
3	APIA3	78	33	64
4	APIA4	87	40	73
5	APIA5	100	52	86
6	APIA6	115	66	100

APID

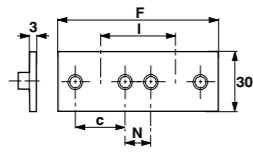

*piastra inferiore doppia
double lower plate*

DIN gruppo group	APID	F mm	c mm	N mm	l mm	n° collari clamps
0	APID0	62	-	-	30	2
1	APID1	82	20	20	40	2
2	APID2	92	26	18	44	2
3	APID3	106	33	19	52	2
4	APID4	122	40	20	60	2
5	APID5	146	52	23	75	2
6	APID6	178	66	24	90	2

APS

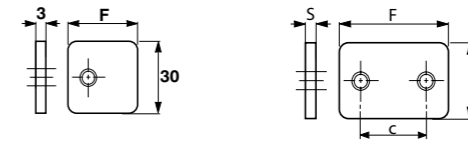

*piastra superiore
upper plate*

DIN gruppo group	APS	F mm	c mm
0	APS0	28	-
1	APS1	37	20
2	APS2	43	26
3	APS3	50	33
4	APS4	57	40
5	APS5	69	52
6	APS6	83	66

APIM

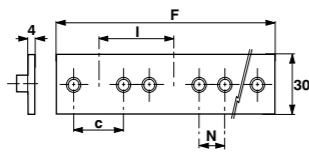

*piastra inferiore multipla
multiple lower plate*

DIN gruppo group	APIM	F mm	c mm	N mm	l mm	n° collari clamps
0	APIM0	307	-	-	30	10
1	APIM1	410	20	20	40	10
2	APIM2	460	26	18	44	10
3	APIM3	540	33	19	52	10
4	APIM4	305	40	20	60	5
5	APIM5	365	52	23	75	5
6	APIM6	449	66	24	90	5

AVTC

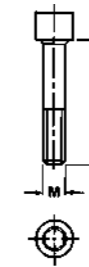

*vite a testa tonda
esagono interno
T.C.E.I. screws*

DIN gruppo group	AVTC	M	e mm
0	AVTC0	M6	20
1	AVTC1	M6	20
2	AVTC2	M6	25
3	AVTC3	M6	30
4	AVTC4	M6	35
5	AVTC5	M6	50
6	AVTC6	M6	60

AVTE

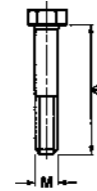

DIN gruppo
group vite a testa esagonale
hexagonal head screw

DIN gruppo group	AVTE	M	e mm
0	AVTE0	M6	30
1	AVTE1	M6	30
2	AVTE2	M6	35
3	AVTE3	M6	40
4	AVTE4	M6	45
5	AVTE5	M6	60
6	AVTE6	M6	70

APMRS

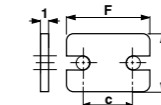

DIN gruppo
group piastra superiore di sicurezza
security upper plate

DIN gruppo group	APMRS	c mm
0	APMRS0	28 -
1	APMRS1	34 20
2	APMRS2	41 26
3	APMRS3	47 33
4	APMRS4	57 40
5	APMRS5	67 52
6	APMRS6	82 66

AVTEA

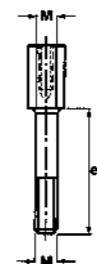

DIN gruppo
group vite a testa esag.
allungata
high hexag. head
screw

DIN gruppo group	AVTEA	M	e mm
0	AVTEA0	M6	20
1	AVTEA1	M6	20
2	AVTEA2	M6	25
3	AVTEA3	M6	30
4	AVTEA4	M6	35
5	AVTEA5	M6	50
6	AVTEA6	M6	60

ADES-G

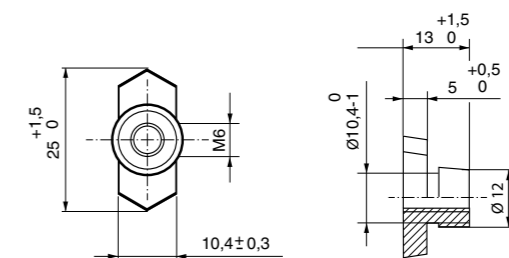

dado esagonale fissaggio binari
hexagonal nut

DIN gruppo group	ADES-G	M	∅ mm
0	ADES-G	M6	12

ABINS

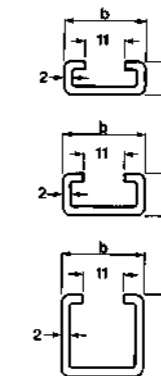

DIN gruppo
group binari portanti
spessore 2 mm rail

DIN gruppo group	ABINS	B mm	H mm
1	ABINS-1	28	11
2	ABINS-2	28	14
3	ABINS-3	28	30

Piastre speciali per serie standard Special plates for standard series

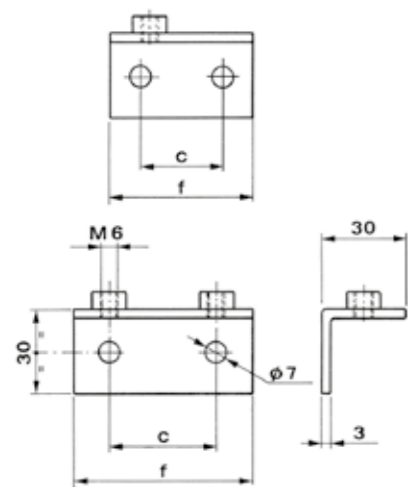

piastra ad angolo
angled plate

DIN gruppo group	APINL	c mm	f mm
0	APINL0	14	32
1	APINL1	20	42
2	APINL2	26	48
3	APINL3	33	55
4	APINL4	40	62
5	APINL5	52	74
6	APINL6	66	88

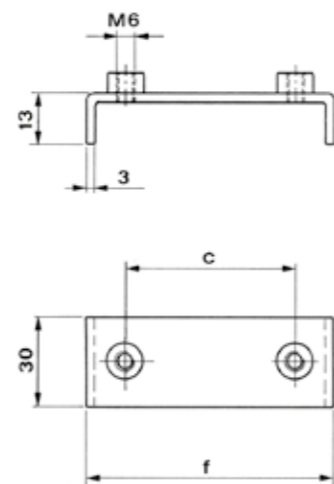

piastra ad angolo
angled plate

DIN gruppo group	APINB	c mm	f mm
0	APINB0	-	-
1	APINB1	20	49
2	APINB2	26	55
3	APINB3	33	63
4	APINB4	40	72
5	APINB5	52	86
6	APINB6	66	99

Collari completi serie doppia Complete clamp standard serie



ADPIN
1

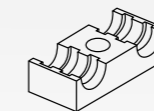

AD...S
2x

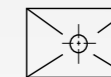

ADPS
1x



ADVTE
1x

AD = polipropilene
polypropylene

MD = polyamide
self-extinguishing

RD = gomma
rubber

Collari completi serie doppi raggruppati

Complete stacking clamps double series



Collari doppi in polipropilene,
poliammide autoestinguente o gomma

Double clamps in polypropylene,
self-extinguishing polyamide or rubber

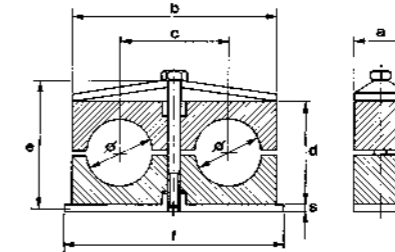

DIN gruppo group	diametro tubo pipe diameter		tipo di collare clamp type			dimensioni in mm dimension in mm							pezzi per confezione box quantity
	Ø mm	pollici / inches G Ø.O.D.	AD polipropilene polypropylene	MD polyamide self-extinguishing	RD gomma rubber	a	b	c	d	f	s	e	
1	6-6		AD1 06-06	MD1 06-06	RD1 06-06	30	36	20	25	37	3	M6x35	50
	6,4-6,4	1/4 - 1/4"	AD1 6,4-6,4	MD1 6,4-6,4	RD1 6,4-6,4								
	8-8	5/16 - 5/16"	AD1 08-08	MD1 08-08	RD1 08-08								
	9,5-9,5	3/8 - 3/8"	AD1 9,5-9,5	MD1 9,5-9,5	RD1 9,5-9,5								
	10-10	1/8 - 1/8"	AD1 10-10	MD1 10-10	RD1 10-10								
	12-12		AD1 12-12	MD1 12-12	RD1 12-12								
2	12,7	1/2 - 1/2"	AD2 12,7-12,7	MD2 12,7-12,7	RD2 12,7-12,7	30	53	29	26	55	5	M8x35	50
	13,5	1/4 - 1/4"	AD2 1/4 - 1/4"	MD2 1/4 - 1/4"	RD2 1/4 - 1/4"								
	14-14		AD2 14-14	MD2 14-14	RD2 14-14								
	15-15		AD2 15-15	MD2 15-15	RD2 15-15								
	16-16	5/8 - 5/8"	AD2 16-16	MD2 16-16	RD2 16-16								
	17,2-17,2	3/8 - 3/8"	AD2 3/8 - 3/8"	MD2 3/8 - 3/8"	RD2 3/8 - 3/8"								
3	18-18		AD2 18-18	MD2 18-18	RD2 18-18	30	67	36	37	70	5	M8x45	50
	19-19	3/4 - 3/4"	AD3 19-19	MD3 19-19	RD3 19-19								
	20-20		AD3 20-20	MD3 20-20	RD3 20-20								
	21,3-21,3	1/2 - 1/2"	AD3 1/2 - 1/2"	MD3 1/2 - 1/2"	RD3 1/2 - 1/2"								
	22-22	7/8 - 7/8"	AD3 22-22	MD3 22-22	RD3 22-22								
	25-25		AD3 25-25	MD3 25-25	RD3 25-25								
4	25,4-25,4	1 - 1"	AD3 25,4-25,4	MD3 25,4-25,4	RD3 25,4-25,4	30	82	45	42	85	5	M8x50	25
	26,9	3/4 - 3/4"	AD4 3/4 - 3/4"	MD4 3/4 - 3/4"	RD4 3/4 - 3/4"								
	28-28		AD4 28-28	MD4 28-28	RD4 28-28								
	30-30		AD4 30-30	MD4 30-30	RD4 30-30								
	32-32	1 1/4 - 1 1/4"	AD5 32-32	MD5 32-32	RD5 32-32								
	33,7-33,7	1 - 1"	AD5 1 - 1"	MD5 1 - 1"	RD5 1 - 1"								
5	35-35		AD5 35-35	MD5 35-35	RD5 35-35	30	106	56	54	110	5	M8x60	25
	38-38	1 1/2 - 1 1/2"	AD5 38-38	MD5 38-38	RD5 38-38								
	40-40		AD5 40-40	MD5 40-40	RD5 40-40								
	42-42	1 1/4 - 1 1/4"	AD5 1 1/4 - 1 1/4"	MD5 1 1/4 - 1 1/4"	RD5 1 1/4 - 1 1/4"								

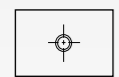

ADPIN
1

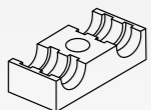

AD...S
4x

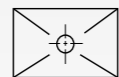

ADPS
1x



ADVTE
1x



APMRSD
1x



ADVTEA
1x

AD = polipropilene
polypropylene

MD = polyamide
self-extinguishing

RD = gomma
rubber

AD...S



tipo H interno liscio
H model smooth inside

tipo normale interno sagomato
normal model profiled inside

DIN gruppo group	semi-collare clamp-half	DIN gruppo group	semi-collare clamp-half
1	AD1 06-06 S	4	AD4 3/4 - 3/4" S
	AD1 6,4-6,4 S		AD4 28-28 S
	AD1 08-08 S		AD4 30-30 S
	AD1 9,5-9,5 S	5	AD5 32-32 S
	AD1 10-10 S		AD5 1 - 1" S
	AD1 12-12 S		AD5 35-35 S
AD2 12,7-12,7 S	AD5 38-38 S		
AD2 1/4 - 1/4" S	AD5 40-40 S		
2	AD2 14-14 S	5	AD5 11/4 - 1 1/4" S
	AD2 15-15 S		
	AD2 16-16 S		
	AD2 3/8 - 3/8" S		
	AD2 18-18 S		
	AD3 19-19 S		
3	AD3 20-20 S	3	AD3 1/2 - 1/2" S
	AD3 22-22 S		
	AD3 25-25 S		
	AD3 25,4-25,4 S		

ADPIN

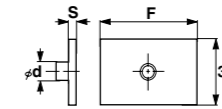

DIN gruppo group	ADPIN	F mm	Ø mm	S
1	ADPIN1	39	12	3
2	ADPIN2	55	14	5
3	ADPIN3	70	14	5
4	ADPIN4	85	14	5
5	ADPIN5	110	14	5

AD...C



tipo H interno liscio
H model smooth inside

tipo normale interno sagomato
normal model profiled inside

DIN gruppo group	coppia-collare clamp-body (2 halves)	DIN gruppo group	coppia-collare clamp-body (2 halves)
1	AD1 06-06 C	4	AD4 3/4 - 3/4" C
	AD1 6,4-6,4 C		AD4 28-28 C
	AD1 08-08 C		AD4 30-30 C
	AD1 9,5-9,5 C	5	AD5 32-32 C
	AD1 10-10 C		AD5 1 - 1" C
	AD1 12-12 C		AD5 35-35 C
AD2 12,7-12,7 C	AD5 38-38 C		
AD2 1/4 - 1/4" C	AD5 40-40 C		
2	AD2 14-14 C	5	AD5 11/4 - 1 1/4" C
	AD2 15-15 C		
	AD2 16-16 C		
	AD2 3/8 - 3/8" C		
	AD2 18-18 C		
	AD3 19-19 C		
3	AD3 20-20 C	3	AD3 1/2 - 1/2" C
	AD3 22-22 C		
	AD3 25-25 C		
	AD3 25,4-25,4 C		

ADPS

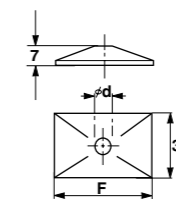

DIN gruppo group	ADPS	F mm	Ø mm
1	ADPS1	35	7
2	ADPS2	52	9
3	ADPS3	66	9
4	ADPS4	81	9
5	ADPS5	105	9

ADPIM

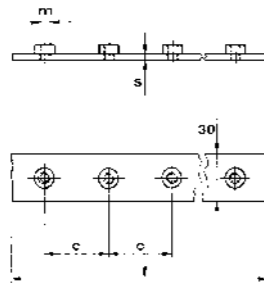

*piastra inferiore multipla
multiple lower plate*

DIN gruppo group	ADPIM	F mm	c mm	s mm	m	n° collari clamps
1	ADPIM1	198	40	3	M6	5
2	ADPIM2	288	58	5	M8	5
3	ADPIM3	360	72	5	M8	5
4	ADPIM4	447	90	5	M8	5
5	ADPIM5	557	112	5	M8	5

ADVTEA

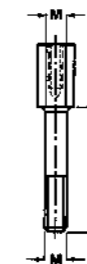

*vite a testa esag. allungata
high hexeg. head screw*

DIN gruppo group	ADVTEA	M	e mm
1	ADVTEA1	M6	25
2	ADVTEA2	M8	20
3	ADVTEA3	M8	29
4	ADVTEA4	M8	34
5	ADVTEA5	M8	47

ADVTE



*vite a testa esagonale
hexagonal head screw*

DIN gruppo group	ADVTE	M	e mm
1	ADVTE1	M6	35
2	ADVTE2	M8	35
3	ADVTE3	M8	45
4	ADVTE4	M8	50
5	ADVTE5	M8	60

APMRSD

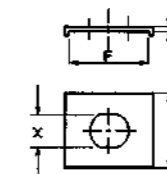
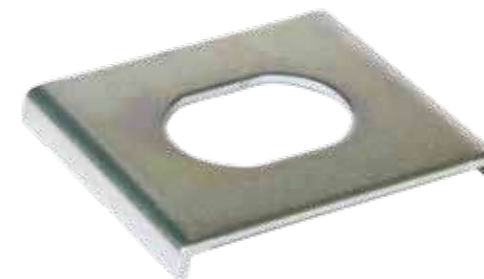

*piastra superiore di sicurezza
security upper plate*

DIN gruppo group	APMRSD	F mm	c mm	d mm
1	APMRSD1	30	30	11
2	APMRSD2	30	30	13
3	APMRSD3	30	30	13
4	APMRSD4	30	30	13
5	APMRSD5	30	30	13

ABINS

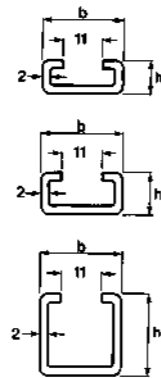

DIN gruppo
group

binari portanti
spessore 2 mm rail

	ABINS	B mm	H mm
1	ABINS-1	28	11
2	ABINS-2	28	14
3	ABINS-3	28	30

ADES-D

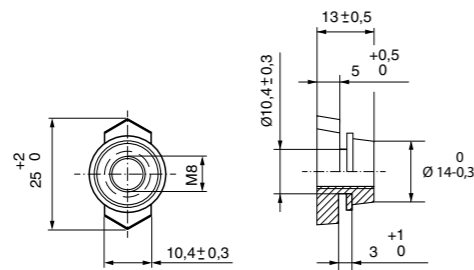

DIN gruppo
group

dado esagonale fissaggio binari
hexagonal nut

	ADES	M	ø mm
1	ADES-G	M6	12
2	ADES-D	M8	14

Elementi di fissaggio per tubi rigidi, flessibili e cavi elettrici

Clamps for hoses, pipes, tubes and cables

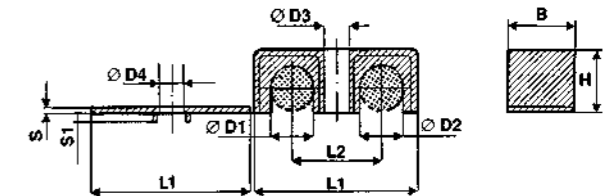

diametro tubo pipe diameter		tipo di collare clamp type	dimensioni in mm dimension in mm										colore colour
ø mm	pollici / inches ø O.D.	ACSD polipropilene polypropylene	L1	L2	B	H	S	S1	D1	D2	D3	D4	
06 - 06	1/4 - 1/4	ACSD 06 - 06	38	22	16	14,2	2	3	6	6	6,9	7	nero/black
08 - 08	1/4 - 1/4	ACSD 08 - 08											
10 - 10	3/8 - 3/8	ACSD 10 - 10	38	22	16	14,5	2	3	10	10	6,9	7	nero/black
12 - 12	3/8 - 3/8	ACSD 12 - 12											
15 - 15	5/8 - 5/8	ACSD 15 - 15	53	31	20	22,5	2	3	15	15	6,9	7	nero/black
19 - 19	3/4 - 3/4	ACSD 19 - 19	70	38	20	30	2	3	19	19	6,9	7	nero/black

Applicazioni: Oleodinamica e pneumatica, Strumentazione, Tecnologia automobilistica, Industria Macchine Utensili, Macchine per plastica, Macchine movimento terra, Macchine agricole, Lubrificazione, Ingegneria meccanica, ecc.

Applications: Oleodynamics and pneumatics, Instrumentation and Automotive Technology, Machine Tool Industry, Gooseneck machines, Earth moving machines, Farm machines, Lubrication, Mechanical Engineering, and so on.

Collari completi serie pesante
Complete clamps heavy duty series

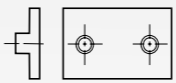
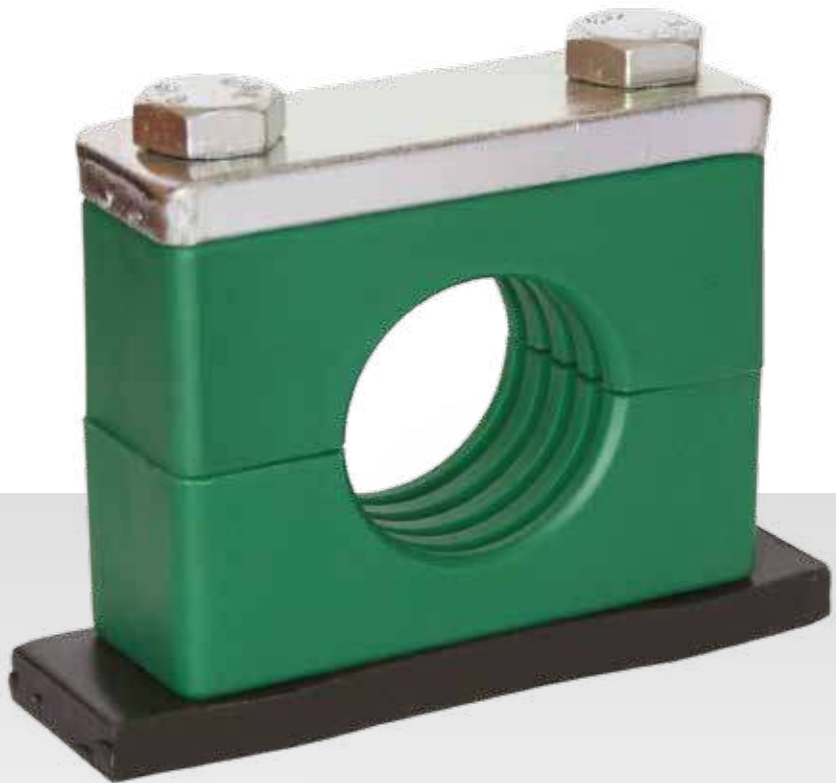

APINP
1

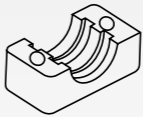

AMP.P....S
2x

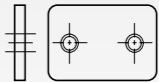

APSP
1



AVTEP
2x

AMP.P = polipropilene
polypropylene
 MMP.P = polyamide
self-extinguishing

RMP.P = gomma
rubber
 AMLL.P = alluminio
aluminium

Collari completo serie pesante raggruppato

Complete stacking clamps heavy duty series

Collari serie pesante in polipropilene,
poliammide autoestinguente, alluminio o gomma

Heavy duty clamps in polypropylene,
self-extinguishing polyamide, aluminium or rubber

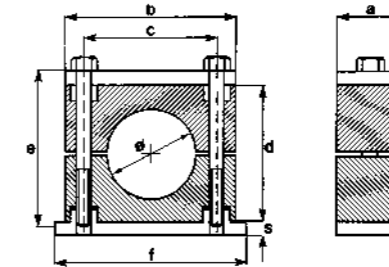

DIN gruppo group	diametro tubo pipe diameter			tipo di collare clamp type				dimensioni in mm dimension in mm						
	Ø mm	pollici / inches G	Ø O.D.	AMP.P polipropilene polypropylene	MMP.P polyamide self-extinguishing	RMP.P gomma rubber	AMLL.P alluminio aluminium	a	b	c	d	f	s	e
1	6			AMP.P1 06	MMP.P1 06	RMP.P1 06	AMLL.P1 06	30	55	33	32	73	8	M10x45
	6,4		1/4"	AMP.P1 6,4	MMP.P1 6,4	RMP.P1 6,4	AMLL.P1 6,4							
	8		5/16"	AMP.P1 08	MMP.P1 08	RMP.P1 08	AMLL.P1 08							
	9,5		3/8"	AMP.P1 9,5	MMP.P1 9,5	RMP.P1 9,5	AMLL.P1 9,5							
	10	1/8"		AMP.P1 10	MMP.P1 10	RMP.P1 10	AMLL.P1 10							
	12			AMP.P1 12	MMP.P1 12	RMP.P1 12	AMLL.P1 12							
	12,7		1/2"	AMP.P1 12,7	MMP.P1 12,7	RMP.P1 12,7	AMLL.P1 12,7							
	13,5	1/4"		AMP.P1 1/4"	MMP.P1 1/4"	RMP.P1 1/4"	AMLL.P1 1/4"							
	14			AMP.P1 14	MMP.P1 14	RMP.P1 14	AMLL.P1 14							
	15			AMP.P1 15	MMP.P1 15	RMP.P1 15	AMLL.P1 15							
2	16		5/8"	AMP.P1 16	MMP.P1 16	RMP.P1 16	AMLL.P1 16	30	70	45	48	102	8	M10x60
	17,2	3/8"		AMP.P1 3/8"	MMP.P1 3/8"	RMP.P1 3/8"	AMLL.P1 3/8"							
	18			AMP.P1 18	MMP.P1 18	RMP.P1 18	AMLL.P1 18							
	19		3/4"	AMP.P2 19	MMP.P2 19	RMP.P2 19	AMLL.P2 19							
	20			AMP.P2 20	MMP.P2 20	RMP.P2 20	AMLL.P2 20							
	21,3	1/2"		AMP.P2 1/2"	MMP.P2 1/2"	RMP.P2 1/2"	AMLL.P2 1/2"							
	22		7/8"	AMP.P2 22	MMP.P2 22	RMP.P2 22	AMLL.P2 22							
	25			AMP.P2 25	MMP.P2 25	RMP.P2 25	AMLL.P2 25							
	25,4		1"	AMP.P2 25,4	MMP.P2 25,4	RMP.P2 25,4	AMLL.P2 25,4							
	26,9	3/4"		AMP.P2 3/4"	MMP.P2 3/4"	RMP.P2 3/4"	AMLL.P2 3/4"							
3	28			AMP.P2 28	MMP.P2 28	RMP.P2 28	AMLL.P2 28	30	85	60	60	140	8	M10x70
	30			AMP.P2 30	MMP.P2 30	RMP.P2 30	AMLL.P2 30							
	30			AMP.P3 30	MMP.P3 30	RMP.P3 30	AMLL.P3 30							
	32		1 1/4"	AMP.P3 32	MMP.P3 32	RMP.P3 32	AMLL.P3 32							
	33,7	1"		AMP.P3 1"	MMP.P3 1"	RMP.P3 1"	AMLL.P3 1"							
	35			AMP.P3 35	MMP.P3 35	RMP.P3 35	AMLL.P3 35							
	38		1 1/2"	AMP.P3 38	MMP.P3 38	RMP.P3 38	AMLL.P3 38							
	40			AMP.P3 40	MMP.P3 40	RMP.P3 40	AMLL.P3 40							
	42	1 1/4"		AMP.P3 1 1/4"	MMP.P3 1 1/4"	RMP.P3 1 1/4"	AMLL.P3 1 1/4"							

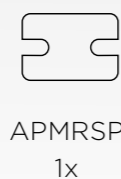
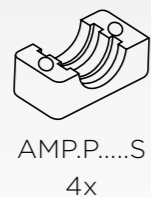
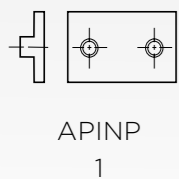

AMP.P = polipropilene
polypropylene

RMP.P = gomma
rubber

MMP.P = polyamide
self-extinguishing

AMLL.P = alluminio
aluminium

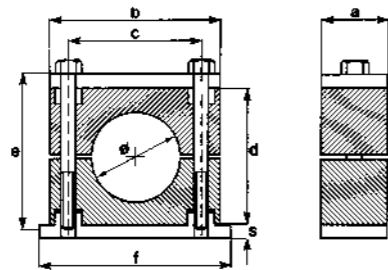

AMP.P...S

DIN gruppo group	diametro tubo pipe diameter		tipo di collare clamp type				dimensioni in mm dimension in mm							
	Ø mm	pollici / inches G Ø O.D.	AMP.P polipropilene polypropylene	MMP.P polyamide self-extinguishing	RMP.P gomma rubber	AMLL.P alluminio aluminium	a	b	c	d	f	s	e	
4	38	1 1/2"	AMP.P4 38	MMP.P4 38	RMP.P4 38	AMLL.P4 38	45	115	90	90	140	10	M12X100	
	42	1 1/4"	AMP.P4 42	MMP.P4 42	RMP.P4 42	AMLL.P4 42								
	44,5	1 3/4"	AMP.P4 44,5	MMP.P4 44,5	RMP.P4 44,5	AMLL.P4 44,5								
	48,3	1 1/2"	AMP.P4 48,3	MMP.P4 48,3	RMP.P4 48,3	AMLL.P4 48,3								
	50		AMP.P4 50	MMP.P4 50	RMP.P4 50	AMLL.P4 50								
	50,8	2"	AMP.P4 50,8	MMP.P4 50,8	RMP.P4 50,8	AMLL.P4 50,8								
	55		AMP.P4 55	MMP.P4 55	RMP.P4 55	AMLL.P4 55								
	57	2 1/4"	AMP.P4 57	MMP.P4 57	RMP.P4 57	AMLL.P4 57								
	60,3	2"	AMP.P4 60,3	MMP.P4 60,3	RMP.P4 60,3	AMLL.P4 60,3								
	63,5	2 1/2"	AMP.P4 63,5	MMP.P4 63,5	RMP.P4 63,5	AMLL.P4 63,5								
5	65		AMP.P5 65	MMP.P5 65	RMP.P5 65	AMLL.P5 65	60	152	122	120	180	10	M16X130	
	70	2 3/4"	AMP.P5 70	MMP.P5 70	RMP.P5 70	AMLL.P5 70								
	73		AMP.P5 73	MMP.P5 73	RMP.P5 73	-								
	75		AMP.P5 75	MMP.P5 75	RMP.P5 75	AMLL.P5 75								
	76,1	2 1/2"	3"	AMP.P5 76,1	MMP.P5 2 1/2"	RMP.P5 2 1/2"								AMLL.P5 2 1/2"
	80		AMP.P5 80	MMP.P5 80	RMP.P5 80	AMLL.P5 80								
	82,5	3 1/4"	AMP.P5 82,5	MMP.P5 82,5	RMP.P5 82,5	AMLL.P5 82,5								
	88,9	3"	3 1/2"	AMP.P5 88,9	MMP.P5 3"	RMP.P5 3"								AMLL.P5 3"
	88,9	3"	3 1/2"	AMP.P6 88,9	MMP.P6 3"	RMP.P6 3"								-
	100		AMP.P6 100	MMP.P6 100	RMP.P6 100	-								
6	101,6	3 1/2"	4"	AMP.P6 101,6	MMP.P6 3 1/2"	RMP.P6 3 1/2"	80	205	168	170	225	15	M20X190	
	108	4 1/4"	AMP.P6 108	MMP.P6 108	RMP.P6 108	-								
	114,3	4"	4 1/2"	AMP.P6 114,3	MMP.P6 4"	RMP.P6 4"								-
	127	4 1/2"	5"	AMP.P6 127	MMP.P6 4 1/2"	RMP.P6 4 1/2"								-
	133		5 1/2"	AMP.P6 133	MMP.P6 133	RMP.P6 133								-
	133		5 1/4"	AMP.P7 133	MMP.P7 133	RMP.P7 133								-
7	139,7	5"	5 1/2"	AMP.P7 139,7	MMP.P7 5"	RMP.P7 5"	90	250	205	200	270	15	M24X220	
	152,4	5 1/2"	6"	AMP.P7 152,4	MMP.P7 5 1/2"	RMP.P7 5 1/2"								-
	165		6 1/2"	AMP.P7 165	MMP.P7 165	RMP.P7 165								-
	168,3	6"	AMP.P7 168,3	MMP.P7 6"	RMP.P7 6"	-								
8	168,3	6"	AMP.P8 168,3	-	-	-	120	320	265	270	340	25	M30X300	
	177,8		7"	AMP.P8 177,8	-	-								-
	193,7		7 5/8"	AMP.P8 193,7	-	-								-
	216		8 1/2"	AMP.P8 216	-	-								-
	219,1	8"	AMP.P8 219,1	-	-	-								



tipo H interno liscio
H model smooth inside



tipo normale interno sagomato
normal model profiled inside

DIN gruppo group	semi-collare clamp-half	DIN gruppo group	semi-collare clamp-half	DIN gruppo group	semi-collare clamp-half
1	AMP.P1 06 S	4	AMP.P4 38 S	7	AMP.P7 133 S
	AMP.P1 6,4 S		AMP.P4 44,5 S		AMP.P7 5" S
	AMP.P1 08 S		AMP.P4 50 S		AMP.P7 5 1/2" S
	AMP.P1 9,5 S		AMP.P4 55 S		AMP.P7 6" S
	AMP.P1 10 S		AMP.P4 57 S		AMP.P7 6" S
	AMP.P1 12 S		AMP.P4 63,5 S		AMP.P8 6" S
	AMP.P1 12,7 S		AMP.P4 65 S		AMP.P8 177,8 S
	AMP.P1 14 S		AMP.P4 70 S		AMP.P8 193,7 S
	AMP.P1 15 S		AMP.P4 70 S		AMP.P8 216 S
	AMP.P1 16 S		AMP.P5 65 S		AMP.P8 8" S
2	AMP.P1 18 S	5	AMP.P5 70 S	6	AMP.P6 3" S
	AMP.P2 19 S		AMP.P5 75 S		AMP.P6 100 S
	AMP.P2 20 S		AMP.P5 80 S		AMP.P6 3 1/2" S
	AMP.P2 1/2" S		AMP.P5 82,5 S		AMP.P6 108 S
	AMP.P2 22 S		AMP.P5 88,9 S		AMP.P6 4" S
	AMP.P2 25 S		AMP.P6 3" S		AMP.P6 4 1/2" S
	AMP.P2 25,4 S		AMP.P6 6" S		AMP.P6 133 S
	AMP.P2 3/4" S		AMP.P6 100 S		
	AMP.P2 28 S		AMP.P6 133 S		
	AMP.P2 30 S				
3	AMP.P3 30 S	6	AMP.P6 108 S		
	AMP.P3 32 S		AMP.P6 4" S		
	AMP.P3 1" S		AMP.P6 4 1/2" S		
	AMP.P3 35 S		AMP.P6 133 S		
	AMP.P3 38 S				
AMP.P3 40 S					
AMP.P3 1 1/4" S					

AMP.P...C



tipo H interno liscio
H model smooth inside



tipo normale interno sagomato
normal model profiled inside

DIN gruppo group	coppia collare pair of halves	DIN gruppo group	coppia collare pair of halves	DIN gruppo group	coppia collare pair of halves
1	AMP.P1 06 C	4	AMP.P4 38 C	7	AMP.P7 133 C
	AMP.P1 6,4 C		AMP.P4 1 1/4" C		AMP.P7 5" C
	AMP.P1 08 C		AMP.P4 44,5 C		AMP.P7 5 1/2" C
	AMP.P1 9,5 C		AMP.P4 1 1/2" C		AMP.P7 165 C
	AMP.P1 10 C		AMP.P4 50 C		AMP.P7 6" C
	AMP.P1 12 C		AMP.P4 50,8 C		AMP.P8 6" C
	AMP.P1 12,7 C		AMP.P4 55 C		AMP.P8 177,8 C
	AMP.P1 1/4" C		AMP.P4 57 C		AMP.P8 193,7 C
	AMP.P1 14 C		AMP.P4 2" C		AMP.P8 216 C
	AMP.P1 15 C		AMP.P4 63,5 C		AMP.P8 8" C
	AMP.P1 16 C		AMP.P4 65 C		
	AMP.P1 3/8" C		AMP.P4 70 C		
	AMP.P1 18 C		AMP.P5 65 C		
	AMP.P2 19 C		AMP.P5 70 C		
	AMP.P2 20 C		AMP.P5 73 C		
AMP.P2 1/2" C	AMP.P5 75 C				
AMP.P2 22 C	AMP.P5 2 1/2" C				
AMP.P2 25 C	AMP.P5 80 C				
AMP.P2 25,4 C	AMP.P5 82,5 C				
AMP.P2 3/4" C	AMP.P5 3" C				
AMP.P2 28 C	AMP.P6 3" C				
AMP.P2 30 C	AMP.P6 100 C				
AMP.P3 30 C	AMP.P6 3 1/2" C				
AMP.P3 32 C	AMP.P6 108 C				
AMP.P3 1" C	AMP.P6 4" C				
AMP.P3 35 C	AMP.P6 4 1/2" C				
AMP.P3 38 C	AMP.P6 133 C				
AMP.P3 40 C					
AMP.P3 1 1/4" C					

APINP

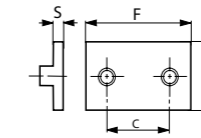

DIN gruppo group	APINP	a mm	F mm	c mm	S mm
1	APINP1	30	77	33	8
2	APINP2	30	87	45	8
3	APINP3	30	103	60	8
4	APINP4	45	140	90	10
5	APINP5	60	180	122	10
6	APINP6	80	225	168	15
7	APINP7	90	270	205	15
8	APINP8	120	340	265	25

APSP

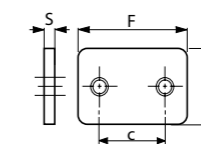

DIN gruppo group	APSP	a mm	F mm	c mm	S mm
1	APSP1	30	55	33	8
2	APSP2	30	70	45	8
3	APSP3	30	85	60	8
4	APSP4	45	120	90	10
5	APSP5	60	152	122	10
6	APSP6	80	205	168	15
7	APSP7	90	250	205	15
8	APSP8	120	320	265	25

AVTEP

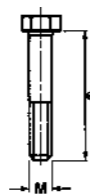

DIN gruppo
group

vite a testa esagonale
hexagonal head screw

	AVTEP	M	e mm
1	AVTEP1	M10	45
2	AVTEP2	M10	60
3	AVTEP3	M10	70
4	AVTEP4	M12	100
5	AVTEP5	M16	130
6	AVTEP6	M20	190
7	AVTEP7	M24	220
8	AVTEP8	M30	300

AVTEAP

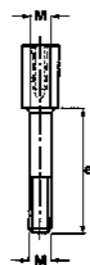

DIN gruppo
group

vite a testa esagonale
hexagonal head screw

	AVTEAP	M	e mm
1	AVTEAP1	M10	26
2	AVTEAP2	M10	41
3	AVTEAP3	M10	52
4	AVTEAP4	M12	83
5	AVTEAP5	M16	110

APMRSP

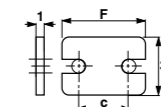

DIN gruppo
group

piastra superiore di sicurezza
security upper plate

	APMRSP	a mm	F mm	c mm	S mm
1	APMRSP1	30	55	33	8
2	APMRSP2	30	70	45	8
3	APMRSP3	30	85	60	8
4	APMRSP4	45	120	90	10
5	APMRSP5	60	152	122	10

ABINP

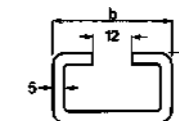

DIN gruppo
group

binari portanti
spessore 5 mm rail

	ABINP	b mm	h mm
1	ABINP1	40	22

ADESP

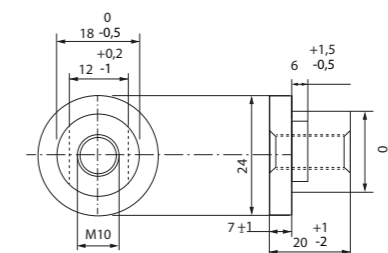

DIN gruppo
group

dado fissaggio binari
rail nut

	ADESP	M	∅ mm
1	ADESP1	M10	18
2	ADESP2	M12	20

Piastre doppie per serie pesante

Double plates for heavy duty series

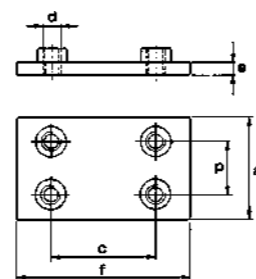
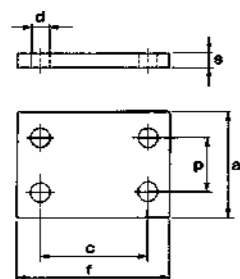

piastra superiore pesante doppia
heavy duty double upper plate

piastra inferiore pesante doppia
heavy duty double lower plate

DIN gruppo group	APSPD	a mm	f mm	s mm	c mm	p mm	d mm
1	APSPD1	60	55	8	33	31	11
2	APSPD2	60	70	8	45	31	11
3	APSPD3	60	85	8	60	31	11
4	APSPD4	90	120	10	90	46	14
5	APSPD5	120	154	10	122	61	18

DIN gruppo group	APINPD	a mm	f mm	s mm	c mm	p mm	m
1	APINPD1	60	77	8	33	31	M10
2	APINPD2	60	87	8	45	31	M10
3	APINPD3	60	103	8	60	31	M10
4	APINPD4	90	140	10	90	46	M12
5	APINPD5	120	180	10	122	61	M16

Supporto tra tubo e cilindro

Double plates for heavy duty series

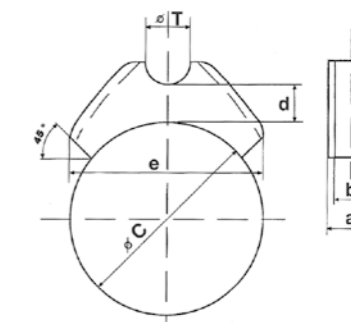

DIN gruppo group	codice code	tipo di collare clamp type		Ø tubo T Ø tube T		dimensioni in mm dimension in mm			
		mm	inc. O.D.	mm	inc. O.D.	a	b	c	d
1	STF 12/50-70	50 ÷ 70	1,96 ÷ 2,75	12	0,47	23	14	12	72
	STF 12/60-80	60 ÷ 80	2,36 ÷ 3,15						
	STF 12/70-90	70 ÷ 90	2,75 ÷ 3,54						
	STF 12/80-100	80 ÷ 100	3,15 ÷ 3,94						
	STF 12/90-110	90 ÷ 110	3,54 ÷ 4,33						
	STF 12/100-120	100 ÷ 120	3,94 ÷ 4,72						
	STF 12/110-130	110 ÷ 130	4,33 ÷ 5,12						
	STF 12/125-150	125 ÷ 150	4,92 ÷ 5,90						
	STF 12/145-170	145 ÷ 170	5,71 ÷ 6,69						
	STF 12/165-200	165 ÷ 200	6,49 ÷ 7,87						
2	STF 20/50-70	50 ÷ 70	1,96 ÷ 2,75	20	0,78	23	14	12	72
	STF 20/60-80	60 ÷ 80	2,36 ÷ 3,15						
	STF 20/70-90	70 ÷ 90	2,75 ÷ 3,54						
	STF 20/80-100	80 ÷ 100	3,15 ÷ 3,94						
	STF 20/90-110	90 ÷ 110	3,54 ÷ 4,33						
	STF 20/100-120	100 ÷ 120	3,94 ÷ 4,72						
	STF 20/110-130	110 ÷ 130	4,33 ÷ 5,12						
	STF 20/125-150	125 ÷ 150	4,92 ÷ 5,90						
	STF 20/145-170	145 ÷ 170	5,71 ÷ 6,69						
	STF 20/165-200	165 ÷ 200	6,49 ÷ 7,87						
3	STF 25/50-70	50 ÷ 70	1,96 ÷ 2,75	25	0,98	23	14	12	72
	STF 25/60-80	60 ÷ 80	2,36 ÷ 3,15						
	STF 25/70-90	70 ÷ 90	2,75 ÷ 3,54						
	STF 25/80-100	80 ÷ 100	3,15 ÷ 3,94						
	STF 25/90-110	90 ÷ 110	3,54 ÷ 4,33						
	STF 25/100-120	100 ÷ 120	3,94 ÷ 4,72						
	STF 25/110-130	110 ÷ 130	4,33 ÷ 5,12						
	STF 25/125-150	125 ÷ 150	4,92 ÷ 5,90						
	STF 25/145-170	145 ÷ 170	5,71 ÷ 6,69						
	STF 25/165-200	165 ÷ 200	6,49 ÷ 7,87						

Applicazioni: Oleodinamica e pneumatica - Macchine utensili - Macchine movimento terra - Macchine agricole - Industria meccanica - Industria in generale - ecc.

Applications: oleodynamic and pneumatic - Machines tools - Earth-moving machines - Farmmachines - Mechanical and metallurgical industry - Oil industry - and so on.

Caratteristiche materiali

Materials properties

	Metodo di prova <i>Test method</i>	Unità di misura <i>Units</i>	Polipropilene Copolimero <i>Meterophasic Copolymers</i>	Poliammide 6-6 <i>Polyamide 6-6</i>	Gomma termoplastica <i>Thermoplastic Rubber</i>	Alluminio <i>Aluminium</i>
FISICHE Physical						
Peso specifico <i>Specific gravity</i>	ASTM D 792	g/cm ³	0,9	1,34	0,964	2,67 kg/dm ³
Assorbimento d'acqua (24h a 23°C in immersione) <i>Water absorption (24h at 23°C immersion)</i>	ASTM D 570	%	Not possible	1	Not possible	Not possible
Ritiro lineare allo stampaggio <i>Mould shrinkage</i>	ASTM D 955	%	1,5 ÷ 2,4	0,2 ÷ 0,5	0,4 ÷ 0,8	0,7%
MECCANICHE Mechanical						
Carico di snervamento a trazione <i>Tensile strenght at yield</i>	ASTM D 638	N/mm2	27	80	6,8 EN 1706	MPA 140
Carico di rottura a trazione <i>Tensile strenght</i>	ASTM D 638	N/mm2	Not available	150	1400	170 ÷ 220
Modulo elastico a trazione <i>Tensile modulus</i>	ASTM D 638	N/mm2	1400	8200	530	68000 ÷ 78000
Allungamento alla rottura <i>Ultimate elongation</i>	ASTM D 638	%	12	3	750	EN 1706 %1
Resistenza all'urto con intaglio IZOD 6.4 mm <i>IZOD impact strenght notched 6.4 mm</i>	ASTM D 256	J/m	85	70	80 SHORE A	Not available
Durezza Rockwell, scala R + L <i>Rockwell hardness, scale R + L</i>	ASTM D 785	—	R84	(L) 150		Brinell en 1706 HBW 80
TERMICHE Thermal						
Temperatura di inflessione 1.82 N mm2 <i>H.D.T. - heat distorsion temperature 1.82 N mm2</i>	ASTM D 648	°C	88	240	70 ÷ 90	380 °C
Temperatura di fusione <i>Melting point</i>	ASTM D 789	°C	150	258	151°, 1 °C	380
Coefficiente di espansione termico lineare <i>Coefficient of linear thermal expansion</i>	ASTM D 696	°C	0,00012	2,5 - 10 ⁵	160 Nm/mk	24 - 10 - 5 (1,6mm: nero/black)
Autoestinguenza <i>Flammability</i>	UL 94	—	Not available	V-0  (1,6mm: nero/black)	Not available	Not available
Temperatura max. d'esercizio <i>Max. exercise temperature</i>	—	°C	-30 +90	-40 +180	-40 +80	+350
ELETTRICHE Electrical						
Rigidità dielettrica - spessore 3 mm <i>Dielectric strenght - thickness 3 mm</i>	ASTM D 149	kV/mm	Not available	20	Not available	20
Costante dielettrica a 1 kHz <i>Dielectric constant, 1kHz</i>	ASTM D 150	—	10 ¹⁸	4,5	2,2 - 2,5	Not available
Resistività di volume <i>Volume resistivity</i>	ASTM D 257	Phm. cm2	10 ¹⁶	4,5 - 1015	Not available	4,5 - 1015
Fattore di dissipazione a 1 kHz <i>Dissipation factor, 1 kHz</i>	DIN 53483	—	0,0002	0,018	Not available	Not available
Resistenza alle correnti striscianti KA sol. A <i>Tracking resistance KA sol. A</i>	DIN 53480	—	3C	KA 3b	KA 3b	KA 3b
Resistenza alle correnti striscianti KB sol. A <i>Tracking resistance KB sol. A</i>	DIN 53480	V	> 680	450	Not available	Not available
Resistenza alle correnti striscianti KC sol. F <i>Tracking resistance KC sol. F</i>	DIN 53480	V	> 600	450	Not available	450

Appendice tecnica - *Technical Appendix*
Certificazioni - *Certification*

Codice Materiale <i>Material Code</i>	PA66 ritardante alla fiamma rinforzato con 25% fibra vetro <i>PA 66 flame retardant reinforced with 25% glass fiber</i>
Materiale di base <i>Basic Material</i>	Poliammide <i>Polyamide</i>
Colore standard <i>Standard Color</i>	Nero <i>Black</i>

Caratteristiche
Features

Certificazioni <i>Certification/Compliance</i>	EC 1907/2006 (REACH) EN 45545-2 NF F 16-101 UL QMFZ2
---------------------------------------------------	---------------------------------------------------------------

1 DEFINIZIONI

Ai fini delle presenti condizioni Generali ai seguenti termini andranno attribuiti i seguenti significati:

“Cliente”: soggetto, avente personalità fisica o giuridica, compresi agenti, distributori, subfornitori, che acquista Prodotti dalla Aegi Componenti Oleodinamici srl

“Contratto”: tutti i documenti contrattuali che disciplinano i rapporti tra il Cliente e la Aegi Componenti Oleodinamici srl con riferimento alla vendita dei Prodotti;

“Prodotti”: prodotti e/o accessori e/o servizi acquistati dal Cliente;

“Ordine”: ordine emesso dal Cliente per l’acquisto dei Prodotti con indicazione esatta della tipologia e della quantità;

“Conferma d’Ordine”: conferma dell’ordine emessa dalla Aegi Componenti Oleodinamici srl in esecuzione delle presenti condizioni di vendita.

1 INTERPRETATION

In these General Conditions the words below have the following meanings:

“Buyer”: the person, firm or company, including its employees, agents, distributors, sub-supplier or representatives, who purchase the Goods from the Aegi Clamps srl.

“Contract”: any contract between Aegi Clamps srl and the Buyer for the sale and purchase of the Goods, including these Conditions.

“Goods”: any goods/accessories/services agreed in the Contract to be supplied to the Buyer by the Aegi Clamps srl.

“Order”: an order for Goods submitted by the Buyer to Aegi Clamps srl for the purchase of Goods with indication of kind and quantity.

“Order Confirmation”: confirmation of the Order by Aegi Clamps srl to the Buyer in accordance with these Sales Conditions.

2 AMBITO DI APPLICAZIONE

Salvo diverso accordo scritto tra le parti, ogni offerta, proposta, ordine d'acquisto, conferma d'ordine e contratto stipulato dal Cliente con Aegi Componenti Oleodinamici srl è regolato dalle presenti Condizioni Generali di Vendita, con esclusione dell'applicabilità delle eventuali condizioni generali di acquisto del Cliente.

2 SCOPE OF APPLICATION

Unless arranged differently by written agreement between the parties, these general terms and conditions of sale shall govern any and all offers, proposals, purchase order and contracts entered by Aegi Clamps srl with customer. General terms and conditions of purchase issued by customers shall not be valid and enforceable between the parties.

3 OFFERTE - ORDINI - CONFERME D'ORDINE

Salvo diversa indicazione scritta contenuta nelle stesse, le offerte formulate da Aegi Componenti Oleodinamici srl hanno una validità di 3 (tre) giorni dalla data di ricezione da parte del Cliente.

Gli ordini di acquisto dei Clienti dovranno essere formalizzati per scritto ed inviati via fax, via e-mail o via posta presso la sede della Aegi Componenti Oleodinamici srl e potranno essere revocati nel caso in cui non pervenisse la Conferma dell'Ordine entro sette giorni dalla ricezione dell'Ordine da parte di Aegi Componenti Oleodinamici srl. Il contratto si intenderà concluso al momento della ricezione, da parte del Cliente della Conferma d'Ordine scritta da parte della Aegi Componenti Oleodinamici srl.

Eventuali modifiche dell'Ordine dovranno essere richieste dal Cliente per iscritto e saranno subordinate all'accettazione scritta da parte di Aegi Componenti Oleodinamici srl.

In caso di cancellazione dell'ordine entro 7 giorni dalla ricezione della Conferma d'Ordine da parte del Cliente, quest'ultimo è tenuto al versamento di un importo pari al 20% del valore dell'Ordine stesso; in caso di cancellazione dell'ordine oltre 7 giorni successivi alla ricezione della Conferma d'Ordine da parte del Cliente, quest'ultimo sarà obbligato al pagamento integrale del valore dell'Ordine cancellato.

3 OFFERS - ORDERS - ORDER CONFIRMATIONS

Offers made by Aegi Clamps srl shall, unless otherwise specified in writing, be valid for 3 (three) days from the date of receipt by the Buyer.

Any and all purchase orders from Buyer (orders) shall be formalized in writing and sent by fax or email to Aegi Clamps srl's head office. The Orders may be annulled if, within 7 (seven) days from reception of the Order, Aegi Clamps Srl does not send its order confirmations. The Contract shall be deemed entered into between the parties as of the date of receipt by Buyer of the written Order Confirmation by Aegi Clamps srl.

Any changes to orders must be requested by the Customer in writing, and will be subject to acceptance in writing by Aegi Clamps srl.

If Buyer cancels an order within 7 days of receiving the Order Confirmation, Buyer shall be required to pay an amount equal to 20% of the order. In the case of cancellation of an order after more than 7 days following receipt of the Order Confirmation, Buyer will be obliged to pay the full value of the order cancelled.





4 DOCUMENTAZIONE - LISTINI PREZZI

Le informazioni e i dati indicati nei cataloghi, nelle brochure, nei listini prezzi e in ogni altra documentazione informativa proveniente dalla Aegi Componenti Oleodinamici srl devono ritenersi puramente indicative e suscettibili di modifica in qualsiasi momento, salvo conferma espressa e scritta da parte di Aegi Componenti Oleodinamici srl in sede di conferma d'ordine.

E' fatto espresso divieto al Cliente di riprodurre con qualsiasi mezzo la predetta comunicazione e di divulgarne il contenuto a terzi, in mancanza di espressa autorizzazione da parte di Aegi Componenti Oleodinamici srl.

4 DOCUMENTS - PRICE LIST

All information and data indicated in Aegi Clamps srl catalogues, leaflets, price lists and other informative documentation, shall be deemed purely indicative, and any be subject to change at any time, except where expressly confirmed in writing by Aegi Clamps srl upon conclusion of Contract.

Buyer must ensure that the terms of the Order and any applicable specification are complete and accurate.

Buyer is expressly forbidden to reproduce this informative documentation by any means whatsoever and disclose its contents to any third party, unless differently arranged by written agreement with Aegi Clamps srl.

5 TERMINI DI CONSEGNA

I termini di consegna, ove pattuiti, hanno valore indicativo. Eventuali ritardi di consegna non danno diritto, salvo le ipotesi di dolo e colpa grave imputabile a Aegi Componenti Oleodinamici srl, alla risoluzione del contratto e/o al risarcimento dei danni sia diretti che indiretti.

I prodotti sono venduti Franco nostra sede; salvo diverso accordo scritto tra le parti Aegi Componenti Oleodinamici srl provvederà alla spedizione dei prodotti al cliente a spese di quest'ultimo secondo le modalità che riterrà più opportune.

E' espressamente esclusa ogni e qualsiasi responsabilità di Aegi Componenti Oleodinamici srl per danni o perdite dei prodotti verificatesi durante il trasporto; pertanto il relativo rischio graverà esclusivamente sul cliente.

Il cliente è tenuto a pena di decadenza, a controllare l'integrità dell'imballaggio e la quantità dei prodotti all'atto del ricevimento, formulando le opportune riserve per iscritto al vettore e dandone immediata comunicazione a Aegi Componenti Oleodinamici srl.

In caso di consegne parziali concordate con il Cliente, i termini di pagamento pattuiti decorreranno, per ciascun lotto di merce, dalla data delle relativa consegna.

5 TERMS OF DELIVERY

Terms of delivery, where agreed, are purely indicative.

Any delays in delivery shall not entitle Buyer to termination of Contract or to compensation for any direct or indirect damage, except in case of malice or gross negligence by Aegi Clamps srl.

Products shall be delivered "Ex Works"; unless otherwise agreed in writing by the parties, Aegi Clamps srl shall dispatch the Products to Buyer, at Buyer's expense, in such manner as Aegi Clamps srl may deem most appropriate.

Aegi Clamps srl shall have no liability whatsoever for any damage to or losses of Products occurring during transport, therefore the related risk shall remain exclusively with Buyer.

Buyer shall, on pain of forfeiture, verify the integrity of packaging and check the quantity of Products upon their receipt, making the appropriate written reserves with the carrier and promptly notifying Aegi Clamps srl if need be.

In case of partial deliveries, agreed between the parties, the terms of payment shall run for each lot as from the date of its delivery.

6 PREZZI - CONDIZIONI DI PAGAMENTO

I prezzi dei prodotti saranno quelli indicati nella relativa Conferma d'Ordine e sono da intendersi al netto di IVA e di ogni altra imposta e/o tassa eventualmente applicabile, nonché delle spese di imballaggio e delle spese di spedizione e trasporto.

I pagamenti potranno essere effettuati a mezzo di titoli di credito solo ove tale modalità di pagamento sia stata specificamente pattuita per iscritto e l'accettazione di tali titoli di credito da parte di Aegi Componenti Oleodinamici srl dovrà intendersi avvenuta sempre e solo salvo buon fine, con esclusione di ogni patto contrario.

Il Cliente non potrà in alcun modo e per nessuna ragione ritardare, sospendere o omettere i pagamenti dovuti, con le modalità indicate.

Ogni eventuale pretesa o ragione del Cliente dovrà essere fatta valere in separato giudizio, con espressa esclusione di qualsiasi compensazione tra quanto dovuto dal Cliente e qualsiasi eventuale ragione o pretesa creditoria dello stesso nei confronti di Aegi Componenti Oleodinamici srl.

In caso di mancato o ritardato pagamento da parte del Cliente, la Aegi Componenti Oleodinamici srl avrà diritto:

- a sospendere l'esecuzione del relativo contratto e/o degli altri contratti eventualmente in essere con il Cliente, ivi inclusi gli eventuali obblighi di garanzia dagli stessi discendenti;
- agli interessi di mora, per ogni giorno di ritardo, al tasso determinato dal D.Lgs 9.10.2002, n. 231;
- al pagamento immediato di tutte le somme dovute dal Cliente, a qualsiasi titolo, anche per altri contratti, con decadenza immediata dal beneficio dell'eventuale termine concesso;
- al rimborso delle spese sostenute per il recupero delle somme non tempestivamente corrisposte dal Cliente;
- al risarcimento di ogni eventuale ulteriore danno.

In ogni caso il Cliente decadrà dal beneficio del termine eventualmente concesso qualora si verifichi una delle seguenti circostanze:

- sopravvenuta insolvenza del Cliente;
- diminuzione delle garanzie prestate;
- mancata erogazione delle garanzie pattuite.

6 PRICES - TERMS OF PAYMENT

The Prices of the products and services shall be those stated in the corresponding Order Confirmation. Prices are indicated net of VAT and any other applicable tax, packaging expenses, shipping and transport costs.

Payments may be made by credit titles only if this mode of payment has been specifically agreed and acceptance of said credit titles by Aegi Clamps srl shall always be deemed subject to final payment. Any covenant to the contrary is expressly excluded. Buyer may in no event and on no account delay, suspend or omit any payments due.

Any claim or title Buyer may have shall be enforced by a separate action, it being expressly understood that Buyer shall not be entitled to offset any sums due by the same against any of its credits or claims.

In case of failure by Buyer to pay any amount due by the same within the agreed deadlines, Aegi Clamps srl shall be entitled to:

- *suspend performance of the corresponding contract any/or any other contracts in place with Buyer, including any warranty obligations;*
- *interest in arrears for each day of delay, at a rate calculated as per Legislative Decree 231 of 9 October 2002;*
- *immediate payment of all sums payable by Aegi Clamps srl, on any ground, even under other contracts, all such sums becoming immediately due;*
- *a refund of the expenses sustained to recover the sums not promptly paid by Buyer;*
- *compensation for any further damage.*

In any case, any and all sums payable by Buyer shall become immediately due whenever one of the following circumstances occur:

- *Buyer becomes insolvent;*
- *The guarantees provided are diminished;*
- *The promised guarantees are not provided.*

7 GARANZIA E RESI

In relazione a prodotti fabbricati e/o forniti da terzi Aegi Componenti Oleodinamici srl sarà responsabile nei confronti del Cliente per gli eventuali vizi degli stessi, esclusivamente entro i limiti di garanzia che la stessa vanta nei confronti di tali fabbricanti e/o fornitori.

In relazione a prodotti assemblati per conto di Aegi Componenti Oleodinamici srl, questa garantisce che, al momento della spedizione, gli stessi siano conformi alle specifiche tecniche eventualmente indicate nella Conferma d'Ordine ed esenti da vizi. In ogni caso, la presente garanzia per vizi avrà la validità massima di un anno dalla data di spedizione dei prodotti.

I vizi riconoscibili dei prodotti forniti da Aegi Componenti Oleodinamici srl dovranno essere denunciati per iscritto dal Cliente entro 8 giorni dal ricevimento dei prodotti stessi, a pena di decadenza; eventuali vizi occulti dovranno essere denunciati per iscritto dal Cliente entro 8 giorni dalla loro scoperta, a pena di decadenza.

La garanzia per vizi prestata da Aegi Componenti Oleodinamici srl cesserà di avere effetto nelle ipotesi in cui:

- il Cliente o terzi effettuino, senza il previo consenso scritto di Aegi Componenti Oleodinamici srl, interventi di riparazione e/o modifica sui prodotti dalla stessa forniti;
- il Cliente o terzi alterino o utilizzino in modo improprio i prodotti;
- il Cliente non consenta alla Aegi Componenti Oleodinamici srl o a terzi da questa incaricati di effettuare ogni ragionevole controllo sui prodotti dichiarati difettosi;
- il Cliente non restituisca tempestivamente a Aegi Componenti Oleodinamici srl, quando la stessa abbia fatto espressa richiesta, i prodotti dichiarati difettosi.

Previa autorizzazione della Aegi Componenti Oleodinamici srl i prodotti dichiarati difettosi o non conformi potranno essere restituiti dal Cliente mediante invio degli stessi presso la sede della Aegi Componenti Oleodinamici srl, accompagnati da una specifica descrizione degli stessi e dei vizi riscontrati, con l'indicazione del numero identificativo dei prodotti, nonché del numero e della data della relativa fattura di vendita.

Nel caso in cui Aegi Componenti Oleodinamici srl, a seguito delle opportune verifiche sui prodotti resi, accerti la sussistenza dei vizi lamentati e la vigenza della garanzia, provvederà, a sua insindacabile scelta, alla riparazione o alla sostituzione dei prodotti.

Qualora i prodotti dovessero essere assemblati, connessi o comunque collegati a componenti di terzi e/o incorporati in prodotti commercializzati dal Cliente e/o da terzi, sarà responsabilità di quest'ultimi verificare la compatibilità dei prodotti forniti con detti componenti e/o prodotti finali. In particolare, sarà esclusivo onere del Cliente specificare il Paese di destinazione dei prodotti finali. In caso contrario sarà esclusiva responsabilità del Cliente l'eventuale difformità dei prodotti rispetto alle norme applicabili nei relativi Paesi di destinazione dei prodotti finali.

E' espressamente esclusa ogni e qualsiasi responsabilità risarcitoria in capo a Aegi Componenti Oleodinamici srl, ai suoi rappresentanti, dipendenti e/o agenti per danni di qualsiasi natura derivanti da vizi dei prodotti o a qualsiasi altro titolo, consequenziali o diretti, ivi incluse a mero titolo esemplificativo fermo macchine, montaggio e smontaggio macchine, interruzione di attività o di affari e perdita di opportunità.

7 WARRANTY AND RETURNS

With reference to products manufactured or supplied by third parties, Aegi Clamps srl shall be liable to Buyer for any defect of the same only within the limits of Aegi Clamp srl's warranty rights against said manufacturers or suppliers.

In relation of the products assembled on behalf of Aegi Clamps srl, Aegi Clamps warrants that said products, at the time of shipping, are in compliance with any technical specifications stated in the relative Order Confirmation and are free from defects. Said warranty against defects shall in any case have a maximum validity of one year from the date of shipping of the products.

Any apparent defects of the products shall be reported by Buyer in writing, on pain of forfeiture, within eight (8) days of receipt of the products. Any hidden defects of the products shall be reported by Buyer in writing, on pain of forfeiture, within eight (8) days from their discovery.

Aegi Clamps's warranty against defects shall no longer be effective whenever:

- *Buyer or any third party alter or misuse the products;*
- *Buyer or any third party make any repair or change to the products supplied by Aegi Clamps srl without the prior written consent of the latter;*
- *Buyer does not allow Aegi Clamps srl or its authorized agents to carry out any and all reasonable control on the products declared to be defective;*
- *Buyer fails to promptly return the defective products to Aegi Clamps srl, where so required by the latter.*

Subject to Aegi Clamps's prior written authorization, defective or non-complying products may be returned by Buyer who shall send them to Aegi Clamps's head office at its own expense. In any such event, returned products shall be accompanied by the return authorization from duly issued by Aegi Clamps srl as well as by a specific description of the products and of the defects encountered in the same, with the specification of the indicative number of products as well as the date of the relative sale invoice.

If, upon due verification of the products returned, Aegi Clamps srl establishes the existence of the alleged defects and applicability of the warranty, Aegi Clamps srl, at its sole discretion, shall either repair the products at its own charge or replace the defective products.

Whenever the products are to be assembled with, connected to or in any case linked to third part components and/or incorporated in products to be marketed by Buyer and/Or by third part, Buyer shall solely be responsible for verification of compatibility of said products with said component and /or final products. More precisely, it shall be Buyer's exclusive duty to indicate the country of destination of the final products in the related Order.

Otherwise, Buyer shall solely be responsible for any discrepancy between the products and the provisions applicable in the related countries of destination of the final products.

In no event shall Aegi Clamps srl, its representative, employees and /or agents be liable for any damages, consequential or indirect, arising from defects in the products or on any other ground, including but not limited to damage deriving from disassembling machinery, withdrawal of products, stay of activity or production and loss of opportunities.

8 INFORMATIVA SULLA PRIVACY

Il Cliente, mediante la sottoscrizione delle presenti Condizioni di Vendita, acconsente al trattamento dei suoi dati personali nel rispetto della disciplina di cui al D.Lgs 30.06.2003, n. 196, per le finalità e secondo le modalità strettamente necessarie ai fini delle operazioni commerciali in essere.

8 8.INFORMATIVE ON PERSONAL DATA TREATMENT

Buyer declares that, by signing or declaration of vision of these General Conditions, gives its consent to the treatment of his personal data in compliance with D.Lgs n. 196 of June 30, 2003, for the purposes and by the means strictly necessary for trading operations.



9 CLAUSOLE FINALI E FORO COMPETENTE

Il Cliente elegge domicilio all'indirizzo indicato in calce alle presenti Condizioni generali di vendita e sarà tenuto a comunicare in forma scritta a Aegi Componenti Oleodinamici srl ogni eventuale variazione. L'invalidità o inefficacia delle singole clausole di ciascun contratto o delle presenti Condizioni Generali non comporterà l'invalidità o inefficacia del relativo contratto o delle altre previsioni ivi contenute. Qualsiasi deroga alle presenti Condizioni dovrà essere effettuata in forma scritta e di comune accordo tra le parti e la sua validità sarà, in ogni caso, limitata allo specifico contratto per cui è stata concordata. I contratti stipulati con il Cliente e le presenti Condizioni Generali di vendita sono regolate e sottoposte alla Legge Italiana. Per ogni controversia relativa all'interpretazione, esecuzione, validità ed efficacia di qualsiasi contratto e/o delle presenti Condizioni di Vendita sarà competente, in via esclusiva, il Foro di Bergamo.

9 FINAL PROVISIONS AND JURISDICTION

Buyer elect domicile at the address reported herein below. Buyer shall notify Aegi Clamps srl in writing or any change in its elected domicile. In default, communications and deliveries to be made by Aegi Clamp srl to Buyer shall be deemed validly made to elected domicile known to Aegi Clamps srl. In the event that any of the provisions of any contract or of these Terms and Conditions becomes invalid or unenforceable in any respect under any law, the validity and enforceability of the remaining provisions shall not in any way affected or impaired. Any and all derogations of these Terms and Conditions shall be agreed in writing by the parties and its validity and effectiveness shall in any case be limited to the specific contract in relation to which said derogation has been agreed. Contracts entered into with Buyer, and these Terms and Conditions shall be governed by the laws of Italy. For any and all disputes or claims arising out or in connection with the interpretation, performance, validity or enforceability of any contract and/or these Terms and Conditions the parties hereby consent to the exclusive jurisdiction of the Court of Bergamo.

AEGI CLAMPS declina ogni tipo di responsabilità attinente al prodotto ad eccezione dei vizi derivanti da difetto di fabbricazione.

I valori di riferimento, menzionati nel catalogo, devono essere considerati indicativi e non assoluti.

AEGI CLAMPS si riserva di apportare tutte le modifiche che riterrà opportune senza obbligo di preavviso.

AEGI CLAMPS declines any kind of liabilities for product malfunction except for product defects caused by manufacturing defects.

The data shown in the catalogue are only indicative.

AEGI CLAMPS reserves the right to make changes at any time without prior notice.



Via A. Einstein, 54/56
20062 Cassano d'Adda | MI | Italy
tel. +39 0363 657.88 | fax +39 0363 65.797
aegi@aegiclamps.it

www.aegiclamps.it